

FOR CAR USE ONLY/NUR FÜR AUTOMOBIL GEBRAUCH/POUR APPLICATION AUTOMOBILE UNIQUEMENT/
PARA USO EN AUTOMÓVILES/SOLO PER L'UTILIZZO IN AUTOMOBILE/ENDAST FÖR BILBRUK



RDS MP3/WMA CD Receiver

CDE-9850Ri

MP3



- **OWNER'S MANUAL**
Please read before using this equipment.
- **BEDIENUNGSANLEITUNG**
Lesen Sie diese Bedienungsanleitung bitte vor Gebrauch des Gerätes.
- **MODE D'EMPLOI**
Veuillez lire avant d'utiliser cet appareil.
- **MANUAL DE OPERACIÓN**
Léalo antes de utilizar este equipo.
- **ISTRUZIONI PER L'USO**
Si prega di leggere prima di utilizzare il attrezzatura.
- **ANVÄNDARHANDLEDNING**
Innan du använder utrustningen bör du läsa igenom denna användarhandledning.

ALPINE ELECTRONICS MARKETING, INC.
1-1-8 Nishi Gotanda,
Shinagawa-ku,
Tokyo 141-0031, Japan
Phone 03-5496-8231

ALPINE ELECTRONICS OF AMERICA, INC.
19145 Gramercy Place, Torrance,
California 90501, U.S.A.
Phone 1-800-ALPINE-1 (1-800-257-4631)

ALPINE ELECTRONICS OF CANADA, INC.
777 Supertest Road, Toronto,
Ontario M3J 2M9, Canada
Phone 1-800-ALPINE-1 (1-800-257-4631)

ALPINE ELECTRONICS OF AUSTRALIA PTY. LTD.
161-165 Princes Highway, Hallam
Victoria 3803, Australia
Phone 03-8787-1200

ALPINE ELECTRONICS GmbH
Frankfurter Ring 117,
80807 München, Germany
Phone 089-32 42 640

ALPINE ELECTRONICS OF U.K. LTD.
Alpine House
Fletchamstead Highway, Coventry CV4 9TW, U.K.
Phone 0870-33 33 763

ALPINE ELECTRONICS FRANCE S.A.R.L.
(RCS PONTOISE B 338 101 280)
98, Rue de la Belle Etoile, Z.I. Paris Nord II,
B.P. 50016, 95945 Roissy Charles de Gaulle
Cedex, France
Phone 01-48638989

ALPINE ITALIA S.p.A.
Viale C. Colombo 8, 20090 Trezzano
Sul Naviglio (MI), Italy
Phone 02-484781

ALPINE ELECTRONICS DE ESPAÑA, S.A.
Portal de Gamarra 36, Pabellón, 32
01013 Vitoria (Alava)-APDO 133, Spain
Phone 945-283588

ALPINE ELECTRONICS (BENELUX) GmbH
Leuvensesteenweg 510-B6,
1930 Zaventem, Belgium
Phone 02-725-13 15

EN

DE

FR

ES

IT

SE

Contents

Operating Instructions

WARNING

WARNING	3
CAUTION	3
PRECAUTIONS	3

Getting Started

Turning Power On and Off	6
Detaching and Attaching the Front Panel	6
Initial System Start-Up	7
Adjusting Volume	7

Radio

Listening to Radio	7
Manual Storing of Station Presets	7
Automatic Memory of Station Presets	8
Tuning to Preset Stations	8
Frequency Search Function	8

RDS

Setting RDS Reception Mode and Receiving RDS Stations	8
Recalling Preset RDS Stations	9
Receiving RDS Regional (Local) Stations	9
PI SEEK Setting	9
Setting PTY31 (Emergency Broadcast) reception	9
Receiving Traffic Information	10
PTY (Programme Type) Tuning	10
Receiving Traffic Information While Playing CD or Radio	10
Priority News	11
Displaying Radio Text	11

CD/MP3/WMA

Playback	11
Repeat Play	12
M.I.X. (Random Play)	12
Searching from CD Text	12

File/Folder Name Search (concerning MP3/WMA)	13
Quick Search	13
About MP3/WMA	13

Sound Setting

Adjusting Bass/Treble/Balance (Between Left and Right)/Fader (Between Front and Rear)/ Defeat	15
Setting the Bass Control	15
Setting the Treble Control	16
Turning Loudness On/Off	16

Other Functions

Displaying the Text	16
---------------------------	----

SETUP

Sound Customizing

Adjusting Source Signal Levels	18
Subwoofer On and Off	18
Setting the Subwoofer System	18

Visual Customizing

Changing Lighting Colour	18
Dimmer Control	18
Scroll Type Setting	18
Scroll Setting (TEXT SCROLL)	18
Demonstration	19

MP3/WMA

Playing MP3/WMA Data (PLAY MODE)	19
----------------------------------------	----

External Device

Connecting to an External Amplifier	19
-------------------------------------------	----

iPod™ (Optional)

Playback	20
Searching for a desired Song	20
Searching by Playlist	20
Searching by artist name	20
Searching by album name	21
Searching by Song name	21
Select Playlist/Artist/Album	21
Quick Search	22
Random Play Shuffle (M.I.X.)	22
Repeat Play	22
Displaying the Text	22



Information

In Case of Difficulty	23
Specifications	25

Installation and Connections

Warning	26
Caution	26
Precautions	26
Installation	27
Connections	28

Operating Instructions

WARNING



WARNING

This symbol means important instructions. Failure to heed them can result in serious injury or death.

DO NOT OPERATE ANY FUNCTION THAT TAKES YOUR ATTENTION AWAY FROM SAFELY DRIVING YOUR VEHICLE.

Any function that requires your prolonged attention should only be performed after coming to a complete stop. Always stop the vehicle in a safe location before performing these functions. Failure to do so may result in an accident.

KEEP THE VOLUME AT A LEVEL WHERE YOU CAN STILL HEAR OUTSIDE NOISE WHILE DRIVING.

Failure to do so may result in an accident.

DO NOT DISASSEMBLE OR ALTER.

Doing so may result in an accident, fire or electric shock.

USE ONLY IN CARS WITH A 12 VOLT NEGATIVE GROUND.

(Check with your dealer if you are not sure.) Failure to do so may result in fire, etc.

KEEP SMALL OBJECTS SUCH AS BATTERIES OUT OF THE REACH OF CHILDREN.

Swallowing them may result in serious injury. If swallowed, consult a physician immediately.

USE THE CORRECT AMPERE RATING WHEN REPLACING FUSES.

Failure to do so may result in fire or electric shock.

DO NOT BLOCK VENTS OR RADIATOR PANELS.

Doing so may cause heat to build up inside and may result in fire.

USE THIS PRODUCT FOR MOBILE 12V APPLICATIONS.

Use for other than its designed application may result in fire, electric shock or other injury.

DO NOT PLACE HANDS, FINGERS OR FOREIGN OBJECTS IN INSERTION SLOTS OR GAPS.

Doing so may result in personal injury or damage to the product.



CAUTION

This symbol means important instructions. Failure to heed them can result in injury or material property damage.

HALT USE IMMEDIATELY IF A PROBLEM APPEARS.

Failure to do so may cause personal injury or damage to the product. Return it to your authorized Alpine dealer or the nearest Alpine Service Centre for repairing.



PRECAUTIONS

Product Cleaning

Use a soft dry cloth for periodic cleaning of the product. For more severe stains, please dampen the cloth with water only. Anything else has the chance of dissolving the paint or damaging the plastic.

Temperature

Be sure the temperature inside the vehicle is between +60°C (+140°F) and -10°C (+14°F) before turning your unit on.

Moisture Condensation

You may notice the CD playback sound wavering due to condensation. If this happens, remove the disc from the player and wait about an hour for the moisture to evaporate.

Damaged Disc

Do not attempt to play cracked, warped, or damaged discs. Playing a bad disc could severely damage the playback mechanism.

Maintenance

If you have problems, do not attempt to repair the unit yourself. Return it to your Alpine dealer or the nearest Alpine Service Station for servicing.

Never Attempt the Following

Do not grip or pull out the disc while it is being pulled back into the player by the automatic reloading mechanism.

Do not attempt to insert a disc into the unit when the unit power is off.

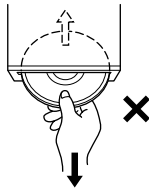

Inserting Discs

Your player accepts only one disc at a time for playback. Do not attempt to load more than one disc.

Make sure the label side is facing up when you insert the disc. "ERROR" will be displayed on your player if you insert a disc incorrectly. If "ERROR" continues to be displayed even though the disc has been inserted correctly, push the RESET switch with a pointed object such as a ballpoint pen.

Playing a disc while driving on a very bumpy road may result in skips, but this will not scratch the disc or damage the player.

New Discs

To prevent the CD from jamming, "ERROR" is displayed if discs with irregular surfaces are inserted or if discs are inserted incorrectly. When a new disc is ejected immediately after initial loading, use your finger to feel around the inside of the center hole and outside edge of the disc. If you feel any small bumps or irregularities, this could inhibit proper loading of the disc. To remove the bumps, rub the inside edge of the hole and outside edge of the disc with a ballpoint pen or other such instrument, then insert the disc again.

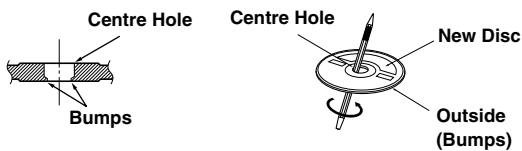

Irregular Shaped Discs

Be sure to use round shape discs only for this unit and never use any special shape discs.

Use of special shape discs may cause damage to the mechanism.

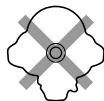

Installation Location

Make sure the CDE-9850Ri will not be installed in a location subjected to:

- Direct sun and heat
- High humidity and water
- Excessive dust
- Excessive vibrations

Correct Handling

Do not drop the disc while handling. Hold the disc so you will not leave fingerprints on the surface. Do not affix tape, paper, or gummed labels to the disc. Do not write on the disc.

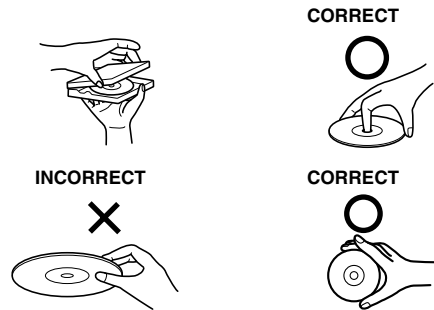

Disc Cleaning

Fingerprints, dust, or soil on the surface of the disc could cause the CD player to skip. For routine cleaning, wipe the playing surface with a clean, soft cloth from the centre of the disc to the outer edge. If the surface is heavily soiled, dampen a clean, soft cloth in a solution of mild neutral detergent before cleaning the disc.



Disc Accessories

There are various accessories available on the market for protecting the disc surface and improving sound quality. However, most of them will influence the thickness and/or diameter of the disc. Using such accessories can cause the disc to be out of standard specifications and may create operational problems. We recommend not using these accessories on discs played in Alpine CD players.

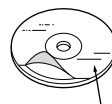

Transparent Sheet

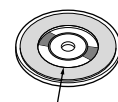

Disc Stabilizer

On handling Compact Discs (CD/CD-R/CD-RW)

- Do not touch the surface.
- Do not expose the disc to direct sunlight.
- Do not affix stickers or labels.
- Clean the disc when it is dusty.
- Make sure that there are no bumps around the disc.
- Do not use commercially available disc accessories.

Do not leave the disc in the car or the unit for a long time. Never expose the disc to direct sunlight. Heat and humidity may damage the CD and you may not be able to play it again.

To customers using CD-R/CD-RW

- If a CD-R/CD-RW cannot be played back, make sure the last recording session was closed (finalized).
- Finalize the CD-R/CD-RW if necessary, and attempt playback again.

About media that can be played.

Use only compact discs with the label side showing the CD logo marks below.



If you use unspecified compact discs, correct performance cannot be guaranteed.

You can play CD-Rs (CD-Recordable)/CD-RWs (CD-ReWritable) which have been recorded only on audio devices. You can also play CD-Rs/CD-RWs containing MP3/WMA formatted audio files.

- Some of the following CDs may not play on this unit:
Flawed CDs, CDs with fingerprints, CDs exposed to extreme temperatures or sunlight (e.g., left in the car or this unit), CDs recorded under unstable conditions, CDs on which a recording failed or a re-recording was attempted, copy-protected CDs which do not conform to the audio CD industry standard.
- Use discs with MP3/WMA files written in a format compatible with this unit. For details, see pages 13-14.
- ROM data other than audio files contained in a disc will not produce sound when played back.

-
- *Windows Media and the Windows logo are trademarks, or registered trademarks of Microsoft Corporation in the United States and/or other countries.*
 - *Apple, the Apple logo and iPod are trademarks of Apple Computer, Inc., registered in the U.S. and other countries.*
 - *“MPEG Layer-3 audio coding technology licensed from Fraunhofer IIS and Thomson.”*
 - *“Supply of this product only conveys a license for private, non-commercial use and does not convey a license nor imply any right to use this product in any commercial (i.e. revenue-generation) real time broadcasting (terrestrial, satellite, cable and/or any other media), broadcasting/streaming via internet, intranets and/or other networks or in other electronic content distribution systems, such as pay-audio or audio-on-demand applications. An independent license for such use is required. For details, please visit <http://www.mp3licensing.com>.”*

Getting Started

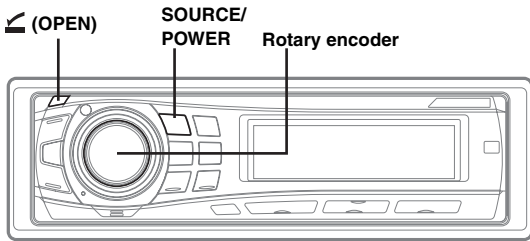

Turning Power On and Off

Press **SOURCE/POWER** to turn on the unit.

- The unit can be turned on by pressing any other button except (OPEN) and Rotary encoder.

Press and hold **SOURCE/POWER** for at least 2 seconds to turn off the unit.

- The first time power is turned on, the volume will start from level 12.

Detaching and Attaching the Front Panel

Be sure to push the Rotary encoder inside the unit before opening the front panel so that the front panel will open completely, otherwise it may be damaged.

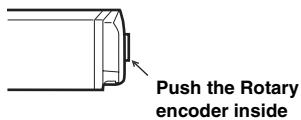

When you push the Rotary encoder again, it pops back out.

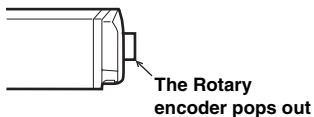

Detaching

- 1 Turn off the unit power.
- 2 Press (OPEN) to open the front panel.

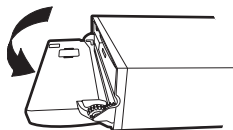

To close the front panel, press the left side until it locks as shown in the figure below.

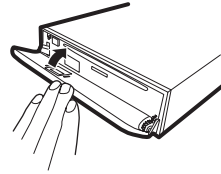

- 3 Grasp the front panel firmly, slide to the left ①, then pull ② to remove.

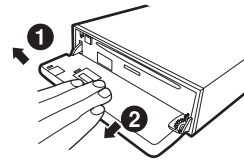

- The front panel may become hot in normal usage (especially the connector terminals on the back of the front panel.) This is not a malfunction.
- To protect the front panel, place it in the supplied carrying case.
- When detaching the front panel, do not apply excessive force as it may result in malfunction.
- Do not leave the front panel open, or drive the car with the panel open as it may result in accident or malfunction.

Attaching

- 1 Insert the right side of the front panel into the main unit. Align the groove on the front panel with the projections on the main unit.
- 2 Push the left side of the front panel until it locks firmly into the main unit.

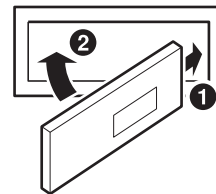

- Before attaching the front panel, make sure that there is no dirt or dust on the connector terminals and no foreign object between the front panel and the main unit.
- Attach the front panel carefully, holding the sides of the front panel to avoid pushing buttons by mistake.

Initial System Start-Up

Be sure to press the RESET switch when using the unit for the first time, after changing the car battery, etc.

- 1 Turn off the unit power.
- 2 Press  (OPEN) to open the front panel, then remove it.
- 3 Press **RESET** with a ballpoint pen or similar pointed object.

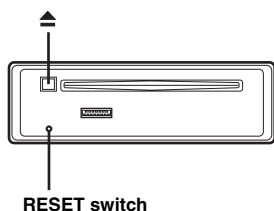

Adjusting Volume

Turn the **Rotary encoder** until the desired sound is obtained.

Controllable With Remote Control

The CDE-9850Ri can be controlled with an optional Alpine remote control. For details, consult your Alpine dealer. Point the optional remote control transmitter at the remote control sensor.

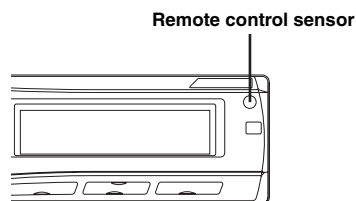

Connectable to Remote Control Interface Box

You can operate this unit from the vehicle's control unit when an Alpine Remote Control Interface Box (optional) is connected. For details, contact your Alpine dealer.

Radio

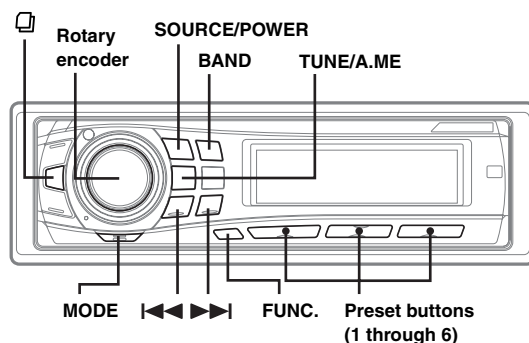

Listening to Radio

- 1 Press **SOURCE/POWER** until a radio frequency appears on the display.
- 2 Press **BAND** repeatedly until the desired radio band is displayed.

F1 (FM1) → F2 (FM2) → F3 (FM3) → MW → LW → F1 (FM1)

- 3 Press **TUNE/A.ME** to select the tuning mode.

DX SEEK (Distance mode) → SEEK (Local mode) → OFF (Manual mode) → DX SEEK

- The initial mode is Distance mode.

Distance mode:

Both strong and weak stations will be automatically tuned in (Automatic Seek Tuning).

Local mode:

Only strong stations will be automatically tuned in (Automatic Seek Tuning).

Manual mode:

The frequency is manually tuned in steps (Manual tuning).

- 4 Press  or  to tune in the desired station. Holding down  or  will change the frequency continuously.

Manual Storing of Station Presets

- 1 Select the radio band and tune in a desired radio station you wish to store in the preset memory.
- 2 Press and hold, for at least 2 seconds, any one of the **preset buttons (1 through 6)** into which you wish to store the station.

The selected station is stored.

The display shows the band, preset number and station frequency memorized.

- A total of 30 stations can be stored in the preset memory (6 stations for each band; FM1, FM2, FM3, MW and LW).
- If you store a station in a preset memory which already has a station, the current station will be cleared and replaced with the new station.
- If the "FUNC" indicator is illuminated, turn off the indicator by pressing **FUNC.**, then you can perform the operation.

Automatic Memory of Station Presets

- 1 Press **BAND** repeatedly until the desired radio band is displayed.
- 2 Press and hold **TUNE/A.ME** for at least 2 seconds. The frequency on the display continues to change while the automatic memory is in progress. The tuner will automatically seek and store 6 strong stations in the selected band. They will be stored into buttons 1 to 6 in order of signal strength. When the automatic memory has been completed, the tuner goes to the station stored in preset location No. 1.
 - If no stations are stored, the tuner will return to the original station you were listening to before the auto memory procedure began.

Tuning to Preset Stations

- 1 Press **BAND** repeatedly until the desired band is displayed.
- 2 Press any one of the station preset buttons (1 through 6) that has your desired radio station in memory. The display shows the band, preset number and frequency of the station selected.
 - If the "FUNC" indicator is illuminated, turn off the indicator by pressing **FUNC.**, then you can perform the operation.

Frequency Search Function

You can search for a radio station by its frequency.

- 1 Press and hold **□** for at least 2 seconds in Radio mode to activate Frequency Search mode.
 - 2 Turn the **Rotary encoder** to select the desired frequency.
 - 3 Press **MODE** to receive the selected frequency.
- Press and hold **□** for at least 2 seconds in the search mode to cancel. Or, the search mode will be cancelled when an operation has not been performed in 10 seconds.

RDS

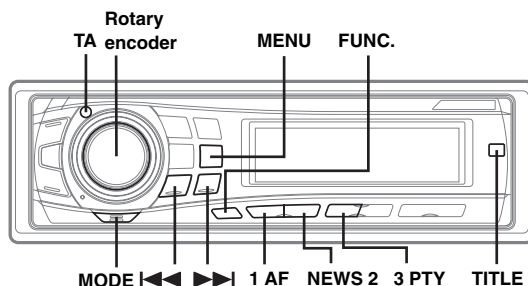

Setting RDS Reception Mode and Receiving RDS Stations

The RDS (Radio Data System) is a radio information system using the 57 kHz subcarrier of regular FM broadcast. The RDS allows you to receive a variety of information such as traffic information, station names, and to automatically re-tune to a stronger transmitter that is broadcasting the same programme.

- 1 Press **FUNC.** so that the "FUNC" indicator lights up.
 - 2 Press **1 AF** to activate the RDS mode.
 - 3 Press **◀◀** or **▶▶** to tune in the desired RDS station.
 - 4 Press **1 AF** again to deactivate the RDS mode.
 - 5 Press **FUNC.** to activate the normal mode. The "FUNC" indicator goes out.
- When the "Setting PTY31 (Emergency Broadcast) reception" (refer to page 9) is set to on, if the unit receives the PTY31 (Emergency Broadcast) signal, the unit will show "ALARM" in the display automatically.

The RDS digital data includes the following:

PI	Programme Identification
PS	Programme Service Name
AF	List of Alternative Frequencies
TP	Traffic Programme
TA	Traffic Announcement
PTY	Programme Type
EON	Enhanced Other Networks

Recalling Preset RDS Stations

- 1 Press FUNC.** so that the “FUNC” indicator lights up.
 - 2 Press 1 AF** to activate the RDS mode.
 - 3 Press FUNC.** to activate the normal mode.
The “FUNC” indicator goes out.
 - 4 Make sure that the “FUNC” indicator light goes out, then press the preset button in which your desired RDS station is preset.**
If the preset station's signal is weak, the unit automatically searches and tunes to a stronger station in the AF (Alternative Frequencies) list.
 - 5 If the preset station and the stations in the AF list cannot be received:**
When the PI SEEK setting is on (refer to “PI SEEK Setting” on page 9), the unit searches again for a station in the PI (Programme Identification) list.
If there are still no stations receivable in the area, the unit displays the frequency of the preset station and the preset number disappears.
If the signal level of the Regional (Local) station being tuned becomes too weak to receive, press the same preset button to tune in a Regional station in other district.
- *For presetting the RDS stations, refer to the Radio Operation section. The RDS stations can be preset in the F1, F2 and F3 bands only.*

Receiving RDS Regional (Local) Stations

- 1 Press MENU** to select the **SETUP** mode, then press **MODE**.
SETUP mode is activated.
BASS ENGINE → SETUP → RETURN (OFF) → BASS ENGINE
- 2 Press I◀◀ or ▶▶I** to select the **RDS REGIONAL** mode, then press **MODE**.
- 3 Turn the Rotary encoder** to select **ON** or **OFF**.
In the OFF mode, the unit automatically keeps receiving the related local RDS station.
- 4 Press MENU** to select **RETURN**.
After 2 seconds, the unit returns to normal mode.
Pressing and holding **MENU** for at least 2 seconds will return to normal mode.

PI SEEK Setting

- 1 Press MENU** to select the **SETUP** mode, then press **MODE**.
SETUP mode is activated.
BASS ENGINE → SETUP → RETURN (OFF) → BASS ENGINE
- 2 Press I◀◀ or ▶▶I** to select the **PI SEEK**, then press **MODE**.
- 3 Turn the Rotary encoder** to select **ON** or **OFF**.
- 4 Press MENU** to select **RETURN**.
After 2 seconds, the unit returns to normal mode.
Pressing and holding **MENU** for at least 2 seconds will return to normal mode.

Setting PTY31 (Emergency Broadcast) reception

Turn PTY31 (Emergency Broadcast) reception ON/OFF.

- 1 Press MENU** to select **SETUP** mode, then press **MODE**.
The SETUP mode is activated.
BASS ENGINE → SETUP → RETURN (OFF) → BASS ENGINE
- 2 Press I◀◀ or ▶▶I** to select the **ALERT PTY31** mode, then press **MODE**.
- 3 Turn the Rotary encoder** to select **ON** or **OFF**.
If you set ON, emergency broadcast are received regardless of source. “ALARM” is displayed during reception.
- 4 Press MENU** to select **RETURN**.
After 2 seconds, the unit returns to normal mode.
Pressing and holding **MENU** for at least 2 seconds will return to normal mode.
When an emergency broadcast is received, the volume level will be automatically changed to the memorized level in the traffic information mode.
For details, refer to “Receiving Traffic Information.”

Receiving Traffic Information

- 1 Press **TA** so that the “TA” indicator lights up.
- 2 Press **◀◀** or **▶▶** to select your desired traffic information station.

When a traffic information station is tuned in, the “TP” indicator lights up.
Traffic information is heard only when it is being broadcast. If traffic information is not being broadcast, the unit is set in the standby mode. When a traffic information broadcast begins, the unit automatically receives it and the display shows “TRF-INFO” for a few seconds.
When the traffic information broadcast is over, the unit will automatically set in the standby mode.

- If the traffic information broadcast signal falls below a certain level, the unit remains in the receiving mode for 1 minute. If the signal remains below a certain level for over 1 minute, the “TA” indicator blinks.
- If you do not want to listen to the traffic information being received, lightly press **TA** to skip that traffic information message. The **TA** mode will remain in the **ON** position to receive the next traffic information message.
- If the volume level is changed while receiving traffic information, the changed volume level will be memorized. When traffic information is received next time, the volume level will be automatically adjusted to the level memorized.
- In the **TA** mode, the **SEEK** tuning selects only the **TP** stations.

PTY (Programme Type) Tuning

- 1 Press **FUNC.** so that the “FUNC” indicator lights up.
- 2 Press **3 PTY** to activate the **PTY** mode, while the unit is in **Radio (FM receiving)** mode.

The Programme Type of the station being currently received will be displayed for 10 seconds.
If there is no receivable **PTY** broadcast, “NO **PTY**” will be displayed for 10 seconds.
If no **RDS** station can be received, the display shows “NO **PTY**.”

- If no operation is performed within 10 seconds after pressing **3 PTY**, the **PTY** mode will be automatically cancelled.

- 3 Press **◀◀** or **▶▶** within 10 seconds after activating the **PTY** mode to choose the desired programme type while the **PTY (programme type)** is being displayed.

Each press scrolls the programme type by one.

┌ - LIGHT M ↔ CLASSICS ↔ OTHER M - ┐
└──────────────────────────────────┘

- 4 Press **3 PTY** within 10 seconds after selecting the programme type to start searching for a station in the selected programme type.

The chosen programme type display blinks during searching and lights when a station is found.

If no **PTY** station is found, “NO **PTY**” will be displayed for 10 seconds.

- 5 Press **FUNC.** to activate the normal mode.
The “FUNC” indicator goes out.

- Operate the unit while the “FUNC” indicator lights up. If no operation is performed within 10 seconds, the “FUNC” indicator goes out.

Receiving Traffic Information While Playing CD or Radio

- 1 Press **TA** so that the “TA” indicator lights up.
- 2 Press **◀◀** or **▶▶** to select a traffic information station if necessary.

When a traffic information broadcast starts, the unit automatically mutes the CD player or the regular FM broadcast.

When the traffic information broadcast finishes, the unit automatically returns to the original source play before the traffic information broadcast began.

When traffic information stations cannot be received:

In the tuner mode:

When the **TP** signal can no longer be received for over 1 minute, the “TA” indicator blinks.

In the CD mode:

When the **TP** signal can no longer be received, the traffic information station of another frequency will be selected automatically.

- The receiver is equipped with the **EON** (Enhanced Other Networks) function in order to keep track of additional alternate frequencies to the **AF** list. The “**EON**” indicator lights up while an **RDS EON** station is being received. If the station being received does not broadcast the traffic information, the receiver automatically tunes in the related station that broadcasts the traffic information when it occurs.

- 3 Press **TA** to deactivate the **Traffic Information** mode.
The “TA” indicator goes out.

Priority News

This function allows you to preset to give priority to the News programme. You will never miss the News programme as the unit automatically gives priority to the News programme whenever it begins broadcasting, and interrupts the programme you are currently listening. This feature is functional when your unit is set to a mode other than the MW and LW modes.

- 1 Press **FUNC.** so that the “FUNC” indicator lights up while the unit is in Radio (FM receiving) mode.
 - 2 Press **NEWS 2** to activate the **PRIORITY NEWS** mode.
The “NEWS” indicator appears in the display.
To disable the PRIORITY NEWS function, press NEWS 2.
- In the PRIORITY NEWS function, unlike in the TA function, the volume does not increase automatically.
- 3 Press **FUNC.** to activate the normal mode, while the unit is in Radio (FM receiving) mode.
The “FUNC” indicator light goes out.

Displaying Radio Text

Text messages from a radio station can be displayed.

Press **TITLE** while receiving FM in the radio mode to select the Radio Text display.

The display will change every time the button is pressed.

If there is PS (Programme Service NAME):

PS (Programme Service Name)* → Radio Text → PS (Programme Service Name)

* Press and hold **TITLE** for at least 2 seconds if PS is displayed in the radio mode, “FREQUENCY” will be displayed for 5 seconds.

If there is no PS (Programme Service Name):

FREQUENCY → Radio Text → FREQUENCY

The display shows “WAITING” for a few seconds, then starts scrolling the text message.

• If there is no receivable text message or the unit cannot receive a text message properly, the display shows “NO TEXT.”

CD/MP3/WMA

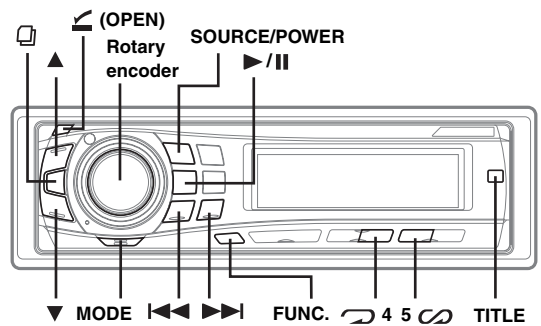

Playback

- 1 Press **(OPEN)**.
The front panel will open.
- 2 Insert a disc with the label side facing up.
The disc will be pulled into the unit automatically.

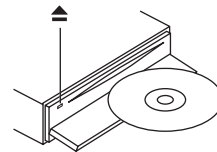

Close the front panel manually.

When a disc is already inserted, press **SOURCE/POWER** to switch to the CD mode.

The mode will change every time the button is pressed.

TUNER → DISC → IPOD* → TUNER

* Only when the iPod is connected.

- 3 While playing back MP3/WMA, press **▲** or **▼** to select the desired folder.
Pressing and holding **▲** or **▼** will change folders continuously.
- 4 Press **◀◀** or **▶▶** to select the desired track (file).
Returning to the beginning of the current track (file):
Press **◀◀**.
Fast backward:
Press and hold **◀◀**.
Advancing to the beginning of the next track (file):
Press **▶▶**.
Fast forward:
Press and hold **▶▶**.
- 5 To pause playback, press **▶/||**.
Pressing **▶/||** again will resume playback.

6 After pressing **OPEN** to open the front panel, press **EJECT** to eject the disc.

- Do not remove a CD during its eject cycle. Do not load more than one disc at a time. A malfunction may result from doing either.
- If the CD does not eject, press and hold **EJECT** for at least 2 seconds.
- The CD-player can play discs containing audio data, MP3 data and WMA data.
- A WMA format file that is protected by DRM (Digital Rights Management) cannot be played back on this unit.
- The track display for MP3/WMA data playback is the file numbers recorded on the disc.
- The playback time may not be correctly displayed when a VBR (Variable Bit Rate) recorded file is played back.

MP3/WMA Play Display

The folder number and file number will be displayed as described below.

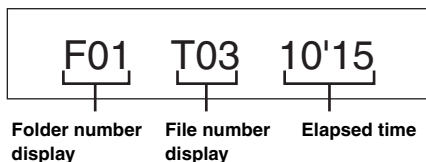

- Press **TITLE** to switch the display. See "Displaying the Text" (page 16) for information about display switching.
- If the folder number or file number is 3 digits, F or T becomes numbers of hundred rank.

Repeat Play

Press **REPEAT** 4 to play back repeatedly the track being played.

The track (file) will be played repeatedly.

Press **REPEAT** 4 again and select off to deactivate repeat play.

CD mode :

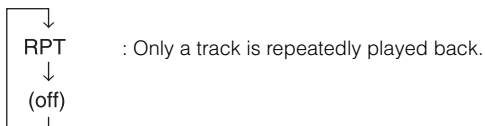

MP3/WMA mode :

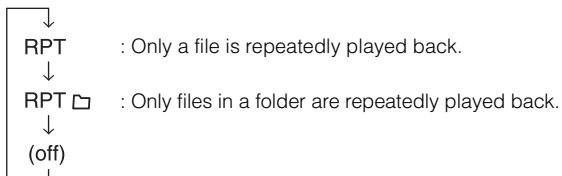

M.I.X. (Random Play)

Press **5** **MIX** in the play or pause mode.

The tracks (files) on the disc will be played back in random sequence.

To cancel M.I.X. play, press **5** **MIX** again.

CD mode :

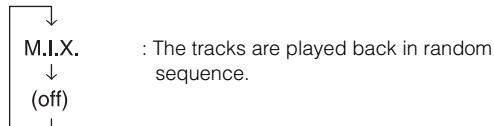

MP3/WMA mode :

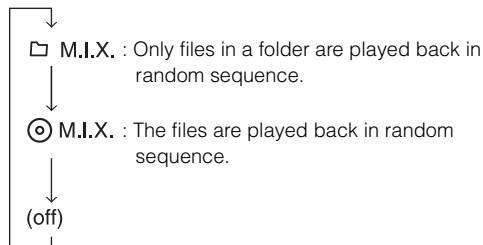

Searching from CD Text

Tracks can be searched and played by using the CD text on the disc. In the case of discs that do not support text, searches can be made by using the track numbers.

1 Press **SEARCH** during play.

This will set the search mode.



2 Turn the **Rotary encoder** to select the desired track, then press **MODE**.

This will play the selected track.



- Press and hold **SEARCH** for at least 2 seconds in the search mode to cancel. Or, the search mode will be cancelled when an operation has not been performed in 10 seconds.
- CD text search cannot be made during M.I.X. play.

File/Folder Name Search (concerning MP3/WMA)



You can display and search the folder and file name while listening to the file currently being played back.

- 1 Press  to activate Search selection mode during MP3/WMA playback.
- 2 Turn the Rotary encoder to select Folder Name Search mode or File Name Search mode, then press .

Folder Name Search mode

- 3 Turn the Rotary encoder to select the desired folder.
- 4 Press  to play back the first file in the selected folder.
 - Press and hold  for at least 2 seconds in the search mode to cancel. Or, the search mode will be cancelled when an operation has not been performed in 10 seconds.
 - While in Folder Name Search mode, press  to switch to File Name Search mode.
 - "ROOT" is displayed for the root folder which does not have folder name.
 - Folder Name search cannot be made during M.I.X. play.
 - Press **FUNC.** in the Search mode to return to the previous step.
 - Folder search cannot be performed if the disc only has root folder.
 - If there is no file in the folder when selecting the folder search mode, "NO FILE" will be displayed for 2 seconds.

File Name Search mode

- 3 Press  or  to select another Folder.
- 4 Select the desired file by turning the Rotary encoder.
- 5 Press **MODE** to playback the selected file.
 - Press and hold  for at least 2 seconds in the search mode to cancel. Or, the search mode will be cancelled when an operation has not been performed in 10 seconds.
 - File Name search cannot be made during M.I.X. play.
 - Press **FUNC.** in the Search mode to return to the previous step.

Quick Search

You can search for tracks (files).

- 1 Press and hold  for at least 2 seconds in the CD/MP3/WMA mode to activate Quick Search mode.
- 2 Turn the Rotary encoder to select a desired track (file).

The selected track is played back immediately.

 - Press and hold  for at least 2 seconds in the search mode to cancel. Or, the search mode will be cancelled when an operation has not been performed in 10 seconds.

About MP3/WMA

CAUTION

Except for private use, duplicating audio data (including MP3/WMA data) or distributing, transferring, or copying it, whether for free or for a fee, without permission of the copyright holder is strictly prohibited by the Copyright Act and by international treaty.

What is MP3?

MP3, whose official name is "MPEG-1 Audio Layer 3," is a compression standard prescribed by the ISO, the International Standardization Organization and MPEG which is a joint activity institution of the IEC.

MP3 files contain compressed audio data. MP3 encoding is capable of compressing audio data at extremely high ratios, reducing the size of music files to as much as one-tenth their original size. This is achieved while still maintaining near CD quality. The MP3 format realizes such high compression ratios by eliminating the sounds that are either inaudible to the human ear or masked by other sounds.

What is WMA?

WMA, or "Windows Media™ Audio," is compressed audio data. WMA is similar to MP3 audio data and can achieve CD quality sound with small file sizes.

Method for creating MP3/WMA files

Audio data is compressed by using MP3/WMA specified software. For details on creating MP3/WMA files, refer to the user's manual for that software. MP3/WMA files that can be played back by this device have the file extension "mp3" / "wma". Files with no extension cannot be played back. (WMA ver. 7.1, 8 and 9 are supported)

Supported playback sampling rates and bit rates

MP3

Sampling rates: 48 kHz, 44.1 kHz, 32 kHz, 24 kHz, 22.05 kHz, 16 kHz, 12 kHz, 11.025 kHz, 8 kHz

Bit rates: 8 - 320 kbps

WMA

Sampling rates: 48 kHz, 44.1 kHz, 32 kHz

Bit rates: 48 - 192 kbps

Note that for sampling rates, this device's frame display (page 16) may not display correctly.

This device may not play back correctly depending on sampling rates.

ID3 tags/WMA tags

This device supports ID3 tag v1 and v2, and WMA tag. If tag data is in an MP3/WMA file, this device can display the title (track title), artist name, and album name ID3 tag/WMA tag data.

This device can only display single-byte alphanumeric characters (up to 30 for ID3 tags and up to 15 for WMA tags) and the underscore. For non-supported characters, "NO SUPPORT" is displayed.

The tag information may not be correctly displayed, depending on the contents.

Producing MP3/WMA discs

MP3/WMA files are prepared, then written to a CD-R or CD-RW using CD-R writing software. A disc can hold up to 510 files/folders (including Root Folders). However, the maximum number of folders is 255.

Media supported

The media that this device can play back are CD-ROMs, CD-Rs, and CD-RWs.

Corresponding File Systems

This device supports discs formatted with ISO9660 Level 1 or Level 2.

Under the ISO9660 standard, there are some restrictions to remember.

The maximum nested folder depth is 8 (including the root directory). The number of characters for a folder/file name is limited.

Valid characters for folder/file names are letters A-Z (all caps), numbers 0-9, and '_' (underscore).

This device also can play back discs in Joliet, Romeo, etc., and other standards that conform to ISO9660. However, sometimes the file names, folder names, etc., are not displayed correctly.

Formats supported

This device supports CD-ROM XA, Mixed Mode CD, Enhanced CD (CD-Extra) and Multi-Session.

This device cannot correctly play back discs recorded with Track At Once or packet writing.

Order of files

The unit plays the files in the order that the writing software writes them. Therefore, the playing order may not be the same as the order you input. The playback order of the folders and files is as follows. However, the folder and file playback order differs from the folder and file number indicated on the display.

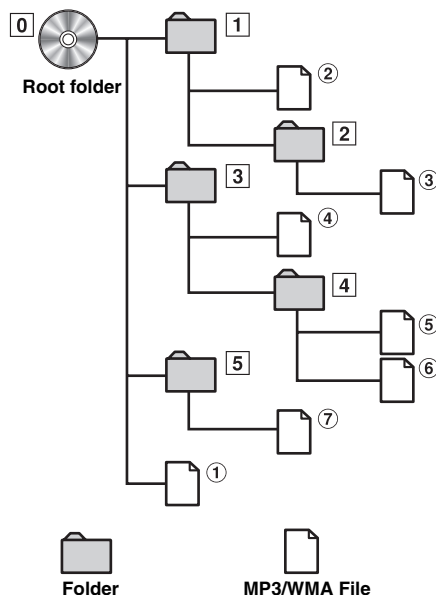

Terminology

Bit rate

This is the "sound" compression rate specified for encoding. The higher the bit rate, the higher the sound quality, but also the larger the files.

Sampling rate

This value shows how many times per second the data is sampled (recorded). For example, music CDs use a sampling rate of 44.1 kHz, so the sound is sampled (recorded) 44,100 times per second. The higher the sampling rate, the higher the sound quality, but also the larger the volume of data.

Encoding

Converting music CDs, WAVE (AIFF) files, and other sound files into the specified audio compression format.

Tag

Song information such as track titles, artist names, album names, etc., written into MP3/WMA files.

MP3: ID3 tag

WMA: WMA tag

Root folder

The root folder is found at the top of the file system. The root folder contains all folders and files.

Sound Setting

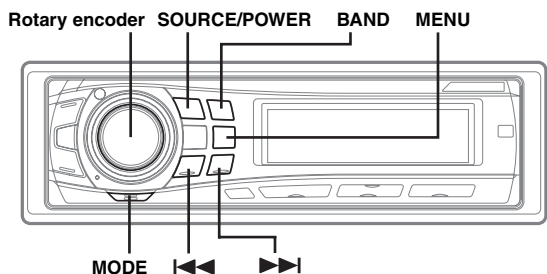

Adjusting Bass/Treble/Balance (Between Left and Right)/Fader (Between Front and Rear)/Defeat

1 Press **MODE** repeatedly to choose the desired mode.

Each press changes the mode as follows:

BASS → TREBLE → SUBW* → BALANCE → FADER → DEFEAT → VOLUME → BASS

Bass Level: -7 ~ +10

Treble Level: -7 ~ +7

Subwoofer : 0 ~ +15

Balance : L15 ~ R15

Fader : R15 ~ F15

Defeat : ON/OFF

Volume : 0 ~ 35

- If **MODE** is not pressed within 5 seconds after selecting the **BASS**, **TREBLE**, **BALANCE**, **FADER**, **DEFEAT** or **SUBW** mode, the unit automatically returns to normal mode.

* When the subwoofer mode is set to OFF, its level cannot be adjusted.

2 Turn the **Rotary encoder** until the desired sound is obtained in each mode.

By setting Defeat ON, previously adjusted settings of BASS and TREBLE will return to the factory defaults.

Setting the Bass Control

You can change the Bass Frequency emphasis to create your own tonal preference.

1 Press **MENU** to select the **BASS ENGINE** mode, then press **MODE**.

BASS ENGINE → SETUP → RETURN (OFF) → BASS ENGINE

2 Press **◀◀** or **▶▶** to select the **BASS** (bass Centre frequency) control mode.

BASS ↔ TREBLE

Setting the Bass Centre Frequency

3-1 Press **SOURCE/POWER** to select the desired bass centre frequency.

80Hz → 100Hz → 120Hz → 60Hz → 80Hz

Emphasize the displayed bass frequency ranges.

Setting the Bass Bandwidth

3-2 Press **BAND** to select the desired bass bandwidth.

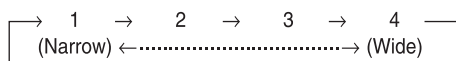

Change the boosted bass bandwidth to wide or narrow. A wide setting will boost a wide range of frequencies above and below the centre frequency. A narrower setting will boost only frequencies near the centre frequency.

Setting the Bass Level

3-3*¹ Turn the **Rotary encoder** to select the desired bass level (-7~+10).

You can emphasize or weaken the bass level.

4 Press **MENU** to select **RETURN**.

After 2 seconds, the unit returns to normal mode.

Pressing and holding **MENU** for at least 2 seconds will return to normal mode.

- If no operation is performed within 60 seconds, the bass control setting will be turned off automatically.
 - The bass level settings will be individually memorized for each source (FM, MW (LW), CD, etc.) until the setting is changed. The bass frequency and bass band width settings adjusted for one source are effective for all other sources (FM, MW (LW), CD etc.).
 - Depending on the connected devices, some functions and display indications do not work. However, Bass Level is still adjustable if an audio processor with the Bass function is connected.
 - This function is inoperable when **DEFEAT** is set to ON.
 - If you press **◀◀** or **▶▶** in the bass control mode, the unit changes to the treble control mode.
- *¹ The adjustment can also be made by pressing **MODE**. Refer to "Adjusting Bass/Treble/Balance (Between Left and Right)/Fader (Between Front and Rear)/Defeat" (page 15).

Bass level indicator's display

Bass level is usually displayed.



Setting the Treble Control

You can change the Treble Frequency emphasis to create your own tonal preference.

- 1 Press **MENU** to select the **BASS ENGINE** mode, then press **MODE**.

BASS ENGINE → SETUP → RETURN (OFF) → BASS ENGINE

- 2 Press **◀◀** or **▶▶** to select the **TREBLE** (Treble Centre Frequency) control mode.

BASS ↔ TREBLE

Setting the Treble Centre Frequency

- 3-1 Press **SOURCE/POWER** to select the desired treble Centre frequency.

10.0kHz → 12.5kHz → 15.0kHz → 7.5kHz → 10.0kHz

Emphasize the displayed treble frequency ranges.

Setting the Treble Level

- 3-2*² Turn the **Rotary encoder** to select the desired treble level (-7~+7).

You can emphasize the treble level.

- 4 Press **MENU** to select **RETURN**.

After 2 seconds, the unit returns to normal mode.

Pressing and holding **MENU** for at least 2 seconds will return to normal mode.

- If no operation is performed within 60 seconds, the treble control setting will be turned off automatically.
- The treble level settings will be individually memorized for each source (FM, MW (LW), CD, etc.) until the setting is changed. The Treble frequency settings adjusted for one source are effective for all other sources (FM, MW (LW), CD, etc.).
- Depending on the connected devices, some functions and display indications do not work. However, Treble Level is still adjustable if an audio processor with the Treble function is connected.
- This function is inoperable when **DEFEAT** is set to **ON**.
- If you press **◀◀** or **▶▶** in the treble control mode, the unit changes to the bass control mode.

*² The adjustment can also be made by pressing **MODE**. Refer to "Adjusting Bass/Treble/Balance (Between Left and Right)/Fader (Between Front and Rear)/Defeat" (page 15).

Turning Loudness On/Off

Loudness introduces a special low- and high-frequency emphasis at low listening levels. This compensates for the ear's decreased sensitivity to bass and treble sound.

Press and hold MODE for at least 2 seconds to activate or deactivate the loudness mode.

"LD" indicator lights.

Other Functions

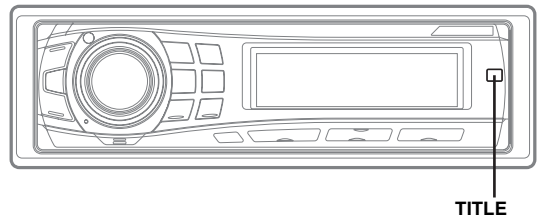

Displaying the Text

Text information, such as the disc name and the track name, will be displayed if playing a CD text compatible disc. It is also possible to display the folder name, the file name, and the tag, etc., while playing MP3/WMA files.

Press **TITLE**.

The display will change every time the button is pressed.

The display in Radio mode:

If there is PS (Programme Service NAME)

PS (Programme Service Name)*¹ → Radio Text →
PS (Programme Service Name)

If there is no PS (Programme Service Name)

FREQUENCY → Radio Text → FREQUENCY

The display in CD mode:

TRACK NO./ELAPSED TIME → TEXT (DISC NAME)*² →
TEXT (TRACK NAME)*² → TRACK NO./ELAPSED TIME

The display in MP3/WMA mode:

FOLDER NO./FILE NO./ELAPSED TIME → FOLDER NAME*³ →
FILE NAME*³ → ARTIST NAME*⁴ → ALBUM NAME*⁴ →
TRACK NAME*⁴ → FRAME*⁵ →
FOLDER NO./FILE NO./ELAPSED TIME

*¹ Press and hold **TITLE** for at least 2 seconds in the PS display mode, "FREQUENCY" will be displayed for 5 seconds.

*² Displayed during playback of a disc with CD Text.

If there is no Text (Disc Name or Track Name), "DISC TEXT"/
"TRACK TEXT" is displayed.

*³ "ROOT" is displayed for the folder name of the root folder which does not have folder name.

If there is no folder name or file name, "FOLDER"/"FILE" is displayed.

*⁴ ID3 tag/WMA tag

If an MP3/WMA file contains ID3 tag/WMA tag information, the ID3 tag/WMA tag information is displayed (track name, artist name, and album name). All other tag data is ignored.

If there is no tag information, "ARTIST"/"ALBUM"/"SONG" will be displayed.

If "SCROLL AUTO" is set in "Scroll Setting (TEXT SCROLL)" (page 18), tag information will automatically be scrolled.

*⁵ The recording sampling rate and bit rate of the MP3/WMA file are displayed. A WMA file of variable bit rate displays the average bit rate.

About the indication display

When displaying Text, the following indicators are lit according to the mode.

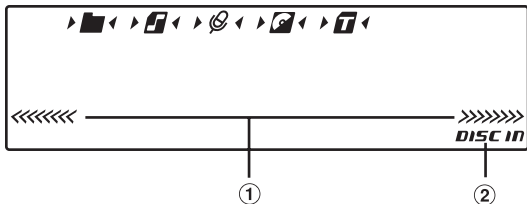

- ① The position of a song being played back is shown lit in the total number of songs shown. The display example is as shown below. Also lights up when operation, such as fast forward, etc., is performed.
- ② Lights up when a disc is inserted

Song position display example



- For example, when the 5th of 10 songs in the disc is played back, “<<<< >>>>” is displayed.

Indicator/ Mode	CD Mode	MP3/WMA Mode	iPod Mode
	—	While displaying Folder Name	—
	—	While displaying File Name	—
	—	While displaying Artist Name*	While displaying Artist Name*
	While displaying Text (Disc Name)	While displaying Album Name*	While displaying Album Name*
	While displaying Text (Track Name)	While displaying Track Name*	While displaying Track Name*

*Tag information

About “Text”

Text:

Text compatible CDs contain text information such as the disc name and track name. Such text information is referred to as “text.”

- Some characters may not be displayed correctly with this device, depending on the character type.
- When the Scroll Setting (page 18) is set to “SCROLL MANU,” press and hold **TITLE** for at least 2 seconds to scroll the Text information only once (TEXT DISPLAY, FOLDER NAME DISPLAY, FILE NAME DISPLAY or TAG DISPLAY mode).
- “NO SUPPORT” is displayed when the desired text information cannot be displayed on this unit.
- The text or tag information may not be correctly displayed, depending on the contents.

SETUP

You can flexibly customize the unit to suit your own preferences and usage. Choose the SETUP menu from Sound Customizing, Visual Customizing, etc., to select your desired setting.

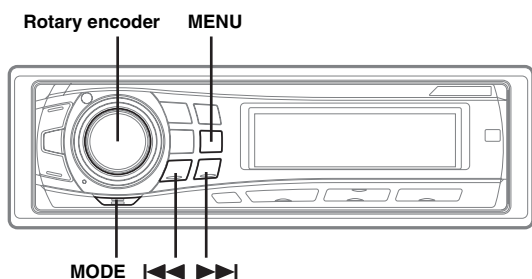

A typical SETUP procedure is shown in steps 1 to 4 as follows. See below for further information about each SETUP menu.

1 Press **MENU** to select the SETUP mode, then press **MODE**.

BASS ENGINE → SETUP → RETURN (OFF) → BASS ENGINE

2 Press ◀◀ or ▶▶ to select the desired SETUP menu, then press **MODE**.

(e.g. Select SUBWOOFER)

FM LEVEL ↔ RDS REGIONAL*¹ ↔ PI SEEK*² ↔
ALERT PTY31*³ ↔ ILLUMINATION ↔ DIMMER ↔
SUBWOOFER ↔ (SUBW SYSTEM)*⁴ ↔ PLAY MODE ↔
SCROLL TYPE ↔ TEXT SCROLL ↔ POWER IC ↔ DEMO ↔
FM LEVEL

*¹ Refer to "Receiving RDS Regional (Local) Stations" (page 9)

*² Refer to "PI SEEK Setting" (page 9)

*³ Refer to "Setting PTY31 (Emergency Broadcast) reception" (page 9)

*⁴ Displayed only when SUBW is ON.

3 Turn the **Rotary encoder** to change the setting.

(e.g. Select SUBW ON or SUBW OFF.)

4 Press **MENU** to select RETURN.

After 2 seconds, the unit returns to normal mode.

Pressing and holding **MENU** for at least 2 seconds will return to normal mode.

Sound Customizing

Adjusting Source Signal Levels

FM-LEVEL HI (Initial setting) / FM-LEVEL LOW

If the difference in volume level between the CD player and FM radio is too great, adjust the FM signal level.

Subwoofer On and Off

SUBW ON (Initial setting) / SUBW OFF

When the subwoofer is on, perform the steps below to adjust the subwoofer output level.

1 In the normal mode, press **MODE** repeatedly to select the SUBW mode.

BASS → TREBLE → SUBW → BALANCE → FADER →
DEFEAT → VOLUME → BASS

2 Adjust the level by turning the Rotary encoder.

Setting the Subwoofer System

SUBW SYS1 (Initial setting) / SUBW SYS2

Select either SYS1 or SYS2 for the desired subwoofer effect.

SUBW SYS1: Subwoofer level changes according to the main volume setting.

SUBW SYS2: Subwoofer level change is different from the main volume setting. For example, even at low volume settings, the subwoofer is still audible.

Visual Customizing

Changing Lighting Colour

ILLUMI BLUE (Initial setting) / RED

You can change the lighting colour of the buttons.

BLUE ↔ RED

Dimmer Control

DIMMER AUTO (Initial setting) / DIMMER MANU

Set the DIMMER control to AUTO to decrease the illumination brightness of the unit with the head lights of the vehicle ON. This mode is useful if you feel the unit's backlighting is too bright at night.

- If your vehicle should have a dimmer control for the dashboard lights, never connect the DIMMER cable (orange) of the radio to this dimmer control.

Scroll Type Setting

SCROLL TYPE1 / SCROLL TYPE2 (Initial setting)

Choose from two scrolling methods.

Select the type you prefer.

Scroll Setting (TEXT SCROLL)

SCROLL AUTO / SCROLL MANU (Initial setting)

This CD player can scroll the disc and track names recorded on CD-TEXT discs, as well as the text information of MP3/WMA files, folder names, and tags.

SCROLL AUTO: The CD text information, the text information of folder and file names, and the tags are scrolled automatically. Also, tag information is automatically scrolled without pressing TITLE in the tag information display mode.

SCROLL MANU: The display is scrolled when a disc is loaded or when a track is changed, etc.

- The unit scrolls CD text names, folder names, file names or tag display.

Demonstration

DEMO ON / DEMO OFF (Initial setting)

This unit has a demonstration feature for the display.

- To quit Demo mode, set to DEMO OFF.

MP3/WMA

Playing MP3/WMA Data (PLAY MODE)

CDDA (Initial setting) / CDDA/MP3

This product can playback CDs containing both CD and MP3/WMA data. However, in some situations (some enhanced CDs), playback may be difficult. For these special cases, you can select playback of CD data only. When a disc contains both CD or the MP3/WMA data, playback starts from the CD data portion of the disc.

- CDDA : Only CD data can be played back.
- CDDA/MP3 : Both CD data and MP3/WMA file tracks can be played back.

- Perform this setting before inserting a disc. If a disc has already been inserted, perform the setting after you remove the disc.

External Device

Connecting to an External Amplifier

POWER IC ON (Initial setting) / POWER IC OFF

When an external amplifier is connected, sound quality can be improved by stopping the power supply of the built-in amplifier.

- POWER IC OFF : Use this mode when the front pre-amplifier of the unit is used to drive an external amplifier connected to the speakers. In this setting, the head unit's internal amplifier has no output to drive speakers.

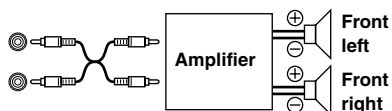

POWER IC ON : The speakers are driven by the built-in amplifier.

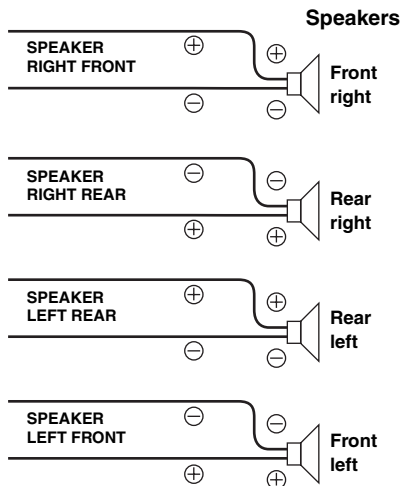

- No sound is produced by the system when the power output is set to OFF.

iPod™ (Optional)

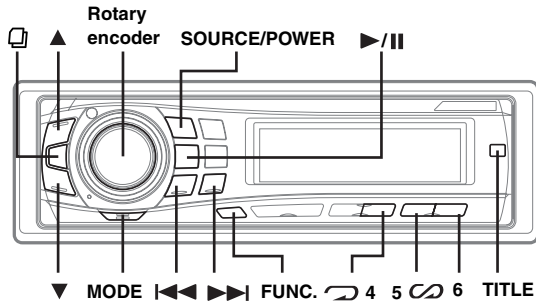

An iPod™, iPod™ mini or iPod™ nano can be connected to the CDE-9850Ri by using the FULL SPEED™ Connection Cable (supplied). When the CDE-9850Ri is connected by using the cable, the controls on the iPod™ are not functional.

About iPods™ usable with this unit

The unit can be used with third generation and above iPod™ photo, iPod™ minis or iPod™ nano. iPod™ Shuffle cannot be used, however.

- Touch wheel or scroll wheel type iPods without the dock connector cannot be connected to the unit.
- The unit can be used with the following iPod versions. Correct function of earlier versions cannot be guaranteed.

Third generation iPod: Ver. 2.3
Fourth generation iPod: Ver. 3.0.2
iPod photo: Ver. 1.0
iPod mini: Ver. 1.3
iPod nano: Ver. 1.0

- The unit cannot be used with the software versions earlier than 22nd Feb.2005. For details about "iPod Software Update", refer to the iPod Instruction Manual.

Playback

- 1 Press **SOURCE/POWER** to switch to the iPod mode.
- 2 Press **◀◀** or **▶▶** to select the desired song.
Return to the beginning of the current song:
Press **◀◀**.
Fast backward:
Press and hold **◀◀**.
Advance to the beginning of the next song:
Press **▶▶**.
Fast forward:
Press and hold **▶▶**.

- 3 To pause playback, press **▶/||**.
Pressing **▶/||** again will resume playback.

- If a song is playing on the iPod when it is connected to the CDE-9850Ri, it will continue playing after the connection.

Searching for a desired Song

An iPod can contain hundreds of songs. By keeping these songs organized in playlists, the CDE-9850Ri can use these to ease song searches.

Searching by Playlist

- 1 Press **□** to activate the search selection mode.
- 2 Turn the **Rotary encoder** to select the **PLAYLIST** search mode, then press **□**.
PLAYLIST ↔ ARTIST ↔ ALBUM ↔ SONG ↔ PLAYLIST
- 3*1 Turn the **Rotary encoder** to select the desired **Playlist**.
- 4 Press **▶/||**.
The selected playlist is played back.



To search for a song in the selected playlist

- 1 After selecting the playlist in step 3*1, press **□** to change to the song search mode of the selected playlist.
 - 2 Turn the **Rotary encoder** to select a song and press **MODE**.
The selected song is played back.
- Press and hold **□** for at least 2 seconds in the search mode to cancel. Or, the search mode will be canceled when an operation has not been performed in 10 seconds.
 - In the search mode, pressing **FUNC.** will return to the previous mode.
 - All songs in the iPod are played back by selecting the stored "iPod name" in step 3*1.
 - Playlist search cannot be made during M.I.X. play.
 - "NO SONG" will be displayed if there are no songs in the selected playlist in the PLAYLIST search mode.







Searching by artist name

- 1 Press **□** to activate the search selection mode.
- 2 Turn the **Rotary encoder** to select the **ARTIST** search mode, then press **□**.
PLAYLIST ↔ ARTIST ↔ ALBUM ↔ SONG ↔ PLAYLIST
- 3*2 Turn the **Rotary encoder** to select the desired **Artist**.
- 4 Press **▶/||**.
All the songs of the selected Artist are played back.



To search for an album of the selected artist

- 1 After selecting the artist in step 3*², press  to change to the album search mode of the selected artist.
- 2*¹ Turn the Rotary encoder to select an album.
- 3 Press  to play back all songs of the selected album.

To search for a song of the selected album



- 1 After selecting the album in step 2*¹, press  to change to the song search mode of the selected album.
 - 2 Turn the Rotary encoder to select a song and press **MODE**.
The selected song is played back.
- Press and hold  for at least 2 seconds in the search mode to cancel. Or, the search mode will be canceled when an operation has not been performed in 10 seconds.
 - In the search mode, pressing **FUNC.** will return to the previous mode.
 - If you choose **ALL** in step 3*², and you press , all songs in iPod are played back. If you choose **ALL**, and you press , the **ALBUM** search mode for all artists is activated.
 - If you choose **ALL** in step 2*¹, and you press , all songs of the selected artist are played back. If you choose **ALL**, and you press , the **SONG** search mode for the selected artist is activated.
 - Artist name search cannot be made during **M.I.X.** play.

Searching by album name



- 1 Press  to activate the search selection mode.
- 2 Turn the Rotary encoder to select the **ALBUM** search mode, then press .
PLAYLIST ↔ ARTIST ↔ ALBUM ↔ SONG ↔ PLAYLIST
- 3*³ Turn the Rotary encoder to select the desired Album.
- 4 Press .
All the songs of the selected Albums are played back.

To search for a song of the selected album

- 1 After selecting the album in step 3*³, press  to change to the song search mode of the selected album.
- 2 Turn the Rotary encoder to select a song and press **MODE**.
The selected song is played back.

- Press and hold  for at least 2 seconds in the search mode to cancel. Or, the search mode will be canceled when an operation has not been performed in 10 seconds.
- In the search mode, pressing **FUNC.** will return to the previous mode.
- If you choose **ALL** in step 3*³, and you press , All songs in iPod are played back. If you choose **ALL**, and you press , the **SONG** search mode for all albums is activated.
- Album name search cannot be made during **M.I.X.** play.



Searching by Song name

- 1 Press  to activate search selection mode.
 - 2 Turn the Rotary encoder to select the **SONG** search mode, then Press .
PLAYLIST ↔ ARTIST ↔ ALBUM ↔ SONG ↔ PLAYLIST
 - 3 Turn the Rotary encoder to select the desired Song.
 - 4 Press **MODE**.
The selected song is played back.
- Press and hold  for at least 2 seconds in the search mode to cancel. Or, the search mode will be canceled when an operation has not been performed in 10 seconds.
 - In the search mode, pressing **FUNC.** will return to the previous mode.
 - Song name search cannot be made during **M.I.X.** play.

Select Playlist/Artist/Album

Playlist/Artist/Album can be easily changed.

For example, if you listen to a song from a selected album, the album can be changed.

- 1 Press  or  to select the desired Playlist/Artist/Album.
- If search selection mode is not activated, only Song is searched, this operation is not possible.
 - If an album is selected from an artist search, the album can be searched.
 - During shuffle (**M.I.X.**) playback, this operation is not possible.

Quick Search

You can search for songs.

1 Press and hold  for at least 2 seconds to activate Quick Search mode.

2 Turn the Rotary encoder to select a desired song.
The selected song is played back immediately.

- Press and hold  for at least 2 seconds in the search mode to cancel. Or, the search mode will be canceled when an operation has not been performed in 10 seconds.
- If many songs are in the iPod, it takes time to search for songs.

Random Play Shuffle (M.I.X.)

The Shuffle function of the iPod is displayed as M.I.X. on the CDE-9850Ri.

Shuffle Albums:

Album shuffle playback plays back all songs in order, then randomly selects the next album. All songs of that album are played back in order, and so on. Any one album is played just once.

Shuffle Songs:

Song shuffle randomly plays back certain selected songs. Any one song plays back just once until all songs have been played back.

1 Press 5 .

The songs will be played back in random sequence.

 M.I.X. → M.I.X. → (off) →  M.I.X.
(Shuffle Albums) (Shuffle Songs)

2 To cancel M.I.X. play, select (off) with the above procedure.

- For details of the search mode, refer to “Searching for a desired Song” (page 20).
- If a song is selected in the album search mode before selecting Shuffle (M.I.X.), the songs will not play back randomly even when Shuffle album is selected.

Shuffle ALL:

Shuffle ALL plays all songs in the iPod randomly. Any one song does not play back again until all songs have been played back.

1 Press 6.

The songs will be played back in random sequence.

M.I.X. → (off) → M.I.X.
(Shuffle ALL)

2 To cancel M.I.X. play, select (off) with the above procedure.

- If Shuffle All is selected, the selected ones which being played back in the search mode are cancelled.

Repeat Play

Only Repeat One is available for the iPod.



Repeat One: A single song is repeatedly played back.

1 Press  4.

The file will be played repeatedly.

RPT → (off) → RPT
(Repeat One)

2 To cancel repeat play, select (off) with the above procedure.

- During repeat playback, no other songs are selectable by pressing  or .

Displaying the Text

You can display the tag information of a song in the iPod.

Press TITLE.

Each press changes the display.

TRACK NO./ELAPSED TIME → ARTIST NAME* →
ALBUM NAME* → SONG TITLE* → TRACK NO./ELAPSED
TIME

* TAG information

If the Scroll setting (page 18) is set to “SCROLL AUTO,” the tag information will scroll automatically.

“ARTIST”/“ALBUM”/“SONG” is displayed if there is no tag information.

- When the Scroll Setting (page 18) is set to “SCROLL MANU,” press and hold **TITLE** for at least 2 seconds to scroll the tag information only once.
- Only alphanumeric characters (ASCII) can be displayed.
- If the artist, album or song name, created in iTunes, has too many characters, songs may not be played back when connected to the adapter. Therefore, a maximum of 250 characters is recommended. The maximum number of characters for the head unit is 128 (128 byte).
- Some characters may not be correctly displayed.
- “NO SUPPORT” is displayed when text information is not compatible with the CDE-9850Ri.

Information

In Case of Difficulty

If you encounter a problem, please turn the power off, then on again. If the unit is still not functioning normally, please review the items in the following checklist. This guide will help you isolate the problem if the unit is at fault. Otherwise, make sure the rest of your system is properly connected or consult your authorized Alpine dealer.

Basic

No function or display.

- Vehicle's ignition is off.
 - If connected following instructions, the unit will not operate with the vehicle's ignition off.
- Improper power lead (Red) and battery lead (Yellow) connections.
 - Check power lead and battery lead connections.
- Blown fuse.
 - Check the fuse of the unit; replace with the proper value if necessary.
- Internal micro-computer malfunctioned due to interference noise etc.
 - Press the RESET switch with a ballpoint pen or other pointed article.

Radio

Unable to receive stations.

- No antenna or open connection in cable.
 - Make sure the antenna is properly connected; replace the antenna or cable if necessary.

Unable to tune stations in the seek mode.

- You are in a weak signal area.
 - Make sure the tuner is in the DX mode.
- If the area you are in is a primary signal area, the antenna may not be grounded and connected properly.
 - Check your antenna connections; make sure the antenna is properly grounded at its mounting location.
- The antenna may not be the proper length.
 - Make sure the antenna is fully extended; if broken, replace the antenna with a new one.

Broadcast is noisy.

- The antenna is not the proper length.
 - Extend the antenna fully; replace it if it is broken.
- The antenna is poorly grounded.
 - Make sure the antenna is grounded properly at its mounting location.

CD

CD Player not functioning.

- Out of operating temperature range +50°C (+120°F) for CD.
 - Allow the vehicle's interior (or trunk) temperature to cool.

CD playback sound is wavering.

- Moisture condensation in the CD Module.
 - Allow enough time for the condensation to evaporate (about 1 hour).

CD insertion not possible.

- A CD is already in the CD player.
 - Eject the CD and remove it.
- The CD is being improperly inserted.
 - Make sure the CD is being inserted following instructions in the CD Player Operation section.

Unable to fast forward or backward the CD.

- The CD has been damaged.
 - Eject the CD and discard it; using a damaged CD in your unit can cause damage to the mechanism.

CD playback sound skips due to vibration.

- Improper mounting of the unit.
 - Securely re-mount the unit.
- The disc is very dirty.
 - Clean the disc.
- The disc has scratches.
 - Change the disc.
- The pick-up lens is dirty.
 - Do not use a commercial available lens cleaner disc. Consult your nearest Alpine dealer.

CD playback sound skips without vibration.

- The disc is dirty or scratched.
 - Clean the disc; damaged disc should be replaced.

Error displays

- Mechanical error
 - Press . After the error indication disappears, insert the disc again. If the above-mentioned solution does not solve the problem, consult your nearest Alpine dealer.

CD-R/CD-RW playback not possible

- Close session (finalization) has not been performed.
 - Perform finalization and attempt playback again.

MP3/WMA

MP3 or WMA is not played back.

- Writing error occurred. The CD format is not compatible.
 - Make sure the CD has been written in a supported format. Refer to "About MP3/WMA" (page 13-14), then rewrite in the format supported by this device.

Audio

The sound is not output from the speakers.

- Unit has no output signal of the internal amplifier.
 - POWER IC is switched to "ON" (page 19).

Indication for CD Player

HI TEMP

- Protective circuit is activated due to high temperature.
 - The indication will disappear when the temperature returns to normal operating range.
-

NO DISC

- No CD is inserted.
 - Insert a CD.
 - Although a disc is inserted, "NO DISC" is displayed and the unit does not start to play or eject the disc.
 - Remove the disc by following these steps:
 - Press the **▲** button again for at least 2 seconds.
 - If the disc still does not eject, consult your Alpine dealer.
-

ERROR

- Mechanism error.
 - 1) Press the **▲** button and eject the CD.
 - If not ejecting, consult your Alpine dealer.
 - 2) When the error indication remains after ejecting, press the **▲** button again.
 - If the error indication still does not turn off after pressing the **▲** button for a few times, consult your Alpine dealer.
 - When "ERROR" is displayed:
 - If that the disc cannot be ejected by pressing **▲**, press the **RESET** switch (refer to page 7) and press **▲** again.
 - If the disc still cannot be ejected, consult your Alpine dealer.
-

PROTECT

- A copy-protected WMA file was played back.
 - You can only play back non-copy-protected files.
-

UNSUPPORTED

- The disc is not written in a MP3/WMA supported format.
 - Use a disc written at the MP3/WMA supported format.
-

Indication for iPod Mode

NO IPOD

- The iPod is not connected.
 - Make sure the iPod is correctly connected (refer to "Connections").
 - Make sure the cable is not bent excessively.
 - The iPod's battery remains low.
 - Refer to the iPod's documentation and charge the battery.
-

NO SONG

- There are no songs in the iPod.
 - Download songs to the iPod and connect to the adapter.
-

ERROR-01

- Communication error
 - Turn the ignition key off, and then set to ON again.
 - Check the display by reconnecting between the iPod and the adapter, using the iPod cable.
-

ERROR-02

- Caused by the iPod Software Version not being compatible with the unit.
 - Update the iPod Software Version to be compatible with the unit.
-

Specifications

FM TUNER SECTION

Tuning Range	87.5 – 108.0 MHz
Mono Usable Sensitivity	0.7 μ V
Alternate Channel Selectivity	80 dB
Signal-to-Noise Ratio	65 dB
Stereo Separation	35 dB
Capture Ratio	2.0 dB

MW TUNER SECTION

Tuning Range	531 – 1,602 kHz
Sensitivity (IEC Standard)	25.1 μ V/28 dB

LW TUNER SECTION

Tuning Range	153 – 281 kHz
Sensitivity (IEC Standard)	31.6 μ V/30 dB

CD SECTION

Frequency Response	5 – 20,000 Hz (\pm 1 dB)
Wow & Flutter (% WRMS)	Below measurable limits
Total Harmonic Distortion	0.008% (at 1 kHz)
Dynamic Range	95 dB (at 1 kHz)
Signal-to-Noise Ratio	105 dB
Channel Separation	85 dB (at 1 kHz)

PICKUP

Wave length	795 nm
Laser power	CLASS I

GENERAL

Power Requirement	14.4 V DC (11–16 V allowable)
Maximum Power Output	50 W \times 4
Maximum Pre-Output Voltage	2 V/10k ohms
Bass	+20/-14dB at 60Hz
Treble	\pm 14dB at 10kHz
Weight	1.6 kg (3 lbs. 8 oz)

CHASSIS SIZE

Width	178 mm (7")
Height	50 mm (2")
Depth	162 mm (6-3/8")

NOSEPIECE SIZE

Width	170 mm (6-11/16")
Height	46 mm (1-13/16")
Depth	24 mm (15/16")

- Due to continuous product improvement, specifications and design are subject to change without notice.

CAUTION



(Bottom side of player)

Installation and Connections

Before installing or connecting the unit, please read the following and pages 3 and 5 of this manual thoroughly for proper use.

Warning

MAKE THE CORRECT CONNECTIONS.

Failure to make the proper connections may result in fire or product damage.

USE ONLY IN CARS WITH A 12 VOLT NEGATIVE GROUND.

(Check with your dealer if you are not sure.) Failure to do so may result in fire, etc.

BEFORE WIRING, DISCONNECT THE CABLE FROM THE NEGATIVE BATTERY TERMINAL.

Failure to do so may result in electric shock or injury due to electrical shorts.

DO NOT SPLICE INTO ELECTRICAL CABLES.

Never cut away cable insulation to supply power to other equipment. Doing so will exceed the current carrying capacity of the wire and result in fire or electric shock.

DO NOT DAMAGE PIPE OR WIRING WHEN DRILLING HOLES.

When drilling holes in the chassis for installation, take precautions so as not to contact, damage or obstruct pipes, fuel lines, tanks or electrical wiring. Failure to take such precautions may result in fire.

DO NOT USE BOLTS OR NUTS IN THE BRAKE OR STEERING SYSTEMS TO MAKE GROUND CONNECTIONS.

Bolts or nuts used for the brake or steering systems (or any other safety-related system), or tanks should NEVER be used for installations or ground connections. Using such parts could disable control of the vehicle and cause fire etc.

KEEP SMALL OBJECTS SUCH AS BATTERIES OUT OF THE REACH OF CHILDREN.

Swallowing them may result in serious injury. If swallowed, consult a physician immediately.

DO NOT INSTALL IN LOCATIONS WHICH MIGHT HINDER VEHICLE OPERATION, SUCH AS THE STEERING WHEEL OR SHIFT LEVER.

Doing so may obstruct forward vision or hamper movement etc. and results in serious accident.

Caution

HAVE THE WIRING AND INSTALLATION DONE BY EXPERTS.

The wiring and installation of this unit requires special technical skill and experience. To ensure safety, always contact the dealer where you purchased this product to have the work done.

USE SPECIFIED ACCESSORY PARTS AND INSTALL THEM SECURELY.

Be sure to use only the specified accessory parts. Use of other than designated parts may damage this unit internally or may not securely install the unit in place. This may cause parts to become loose resulting in hazards or product failure.

ARRANGE THE WIRING SO IT IS NOT CRIMPED OR PINCHED BY A SHARP METAL EDGE.

Route the cables and wiring away from moving parts (like the seat rails) or sharp or pointed edges. This will prevent crimping and damage to the wiring. If wiring passes through a hole in metal, use a rubber grommet to prevent the wire's insulation from being cut by the metal edge of the hole.

DO NOT INSTALL IN LOCATIONS WITH HIGH MOISTURE OR DUST.

Avoid installing the unit in locations with high incidence of moisture or dust. Moisture or dust that penetrates into this unit may result in product failure.

Precautions

- Be sure to disconnect the cable from the (-) battery post before installing your CDE-9850Ri. This will reduce any chance of damage to the unit in case of a short-circuit.
- Be sure to connect the colour coded leads according to the diagram. Incorrect connections may cause the unit to malfunction or damage to the vehicle's electrical system.
- When making connections to the vehicle's electrical system, be aware of the factory installed components (e.g. on-board computer). Do not tap into these leads to provide power for this unit. When connecting the CDE-9850Ri to the fuse box, make sure the fuse for the intended circuit of the CDE-9850Ri has the appropriate amperage. Failure to do so may result in damage to the unit and/or the vehicle. When in doubt, consult your Alpine dealer.
- The CDE-9850Ri uses female RCA-type jacks for connection to other units (e.g. amplifier) having RCA connectors. You may need an adaptor to connect other units. If so, please contact your authorized Alpine dealer for assistance.
- Be sure to connect the speaker (-) leads to the speaker (-) terminal. Never connect left and right channel speaker cables to each other or to the vehicle body.

IMPORTANT

Please record the serial number of your unit in the space provided below and keep it as a permanent record. The serial number or the engraved serial number is located on the bottom of the unit.

SERIAL NUMBER: _____

INSTALLATION DATE: _____

INSTALLATION TECHNICIAN: _____

PLACE OF PURCHASE: _____

Installation

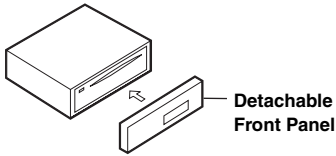

Caution

When you install this unit in your car, do not remove the detachable front panel.
If the detachable front panel is removed during installation, you might press too hard and warp the metal plate that holds it in place.

Accessory List

- Head unit1
- Power cable.....1
- FULL SPEED™ Connection Cable.....1
- Mounting sleeve.....1
- Carrying case.....1
- Rubber Cap1
- Hex Bolt1
- Screw (M5 × 8).....4
- Owner's Manual 1 set

• The main unit must be mounted within 35 degrees of the horizontal plane, back to front.

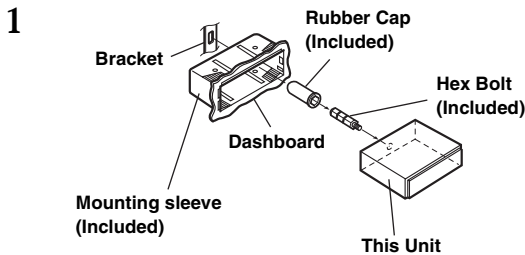
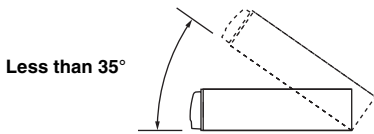

Slide mounting sleeve from main unit (see "Removal" on page 27). Slide the mounting sleeve into the dashboard and fix it with the metal shackles.

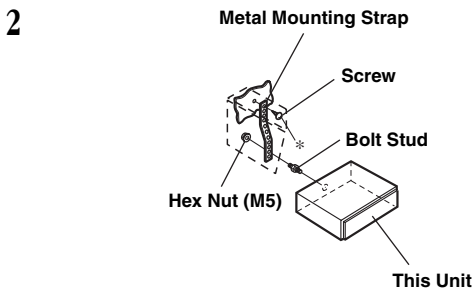

When your vehicle has the Bracket, mount the long hex bolt onto the rear panel of the CDE-9850Ri and put the Rubber Cap on the hex bolt. If your vehicle does not have the Mounting Support, reinforce the head unit with the metal mounting strap (not supplied). Connect all the leads of the CDE-9850Ri according to details described in the CONNECTION section.

- For the screw *, provide a proper screw to the chassis installing location.

- 3** Slide the CDE-9850Ri into the dashboard. When the unit is in place, make sure the locking pins are fully seated in the down position. This can be done by pressing firmly in on the unit while pushing the locking pin down with a small screwdriver. This ensures that the unit is properly locked and will not accidentally come out from the dashboard. Install the Detachable Front Panel.

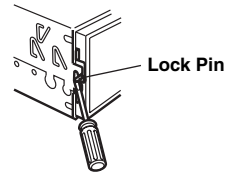

Removal

1. Remove the detachable front panel.
2. Use a small screwdriver (or similar tool) to push the locking pins to the "up" position (see above drawing). As each pin is unlocked, gently pull out on the unit to make sure it does not re-lock before unlocking the second pin.
3. Pull the unit out, keeping it unlocked as you do so.

<JAPANESE CAR>

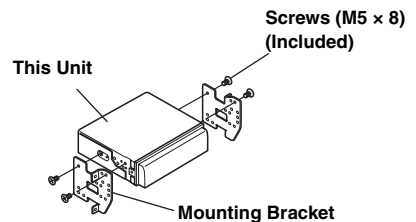
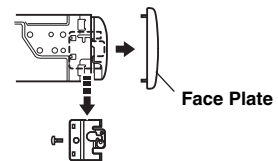

Connections

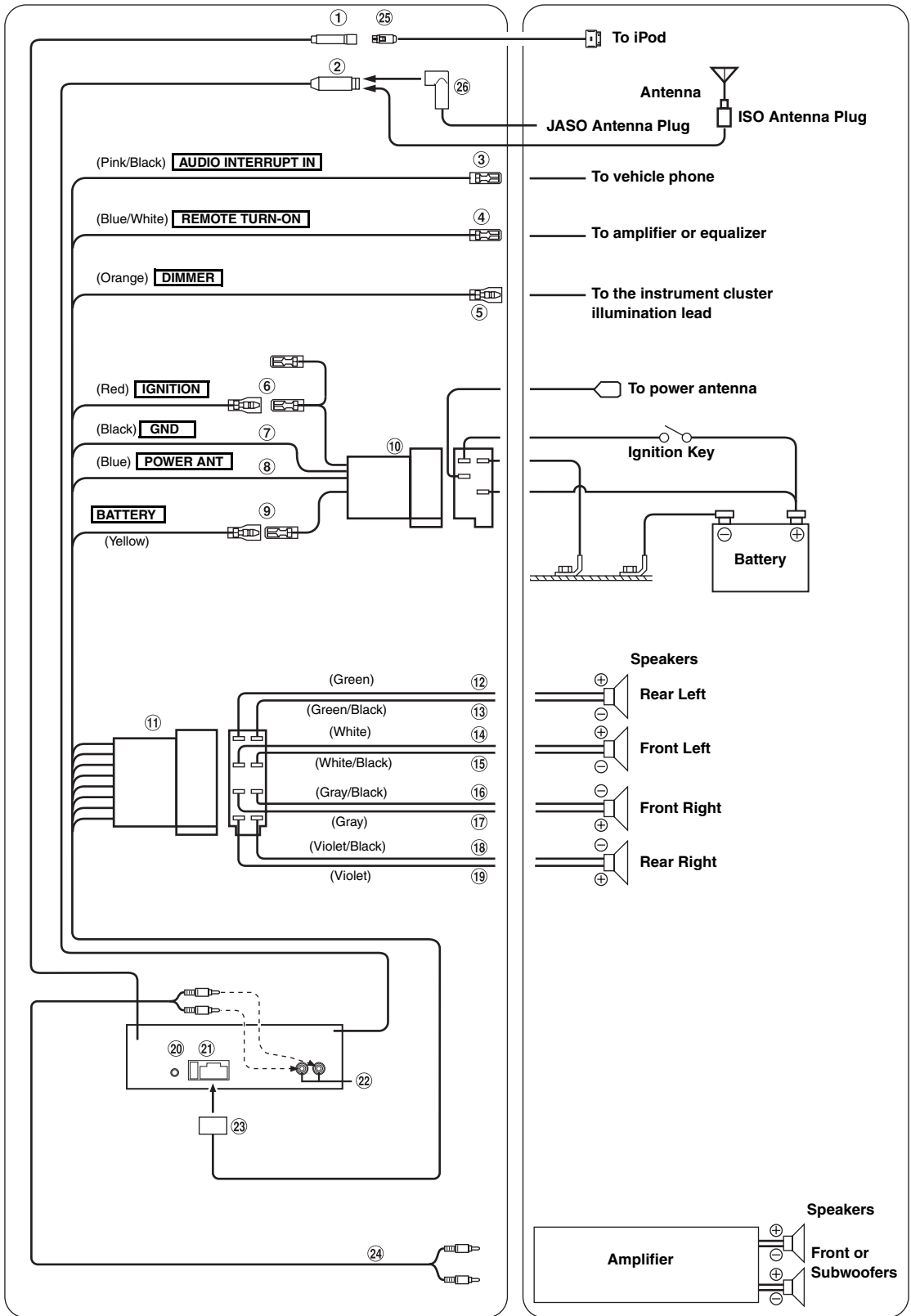

- ① **iPod Direct Connector**
iPod control signals.
Connect this to an iPod, using the FULL SPEED™ Connection Cable (supplied).
 - ② **Antenna Receptacle**
 - ③ **Audio Interrupt In Lead (Pink/Black)**
Connect this lead to the Audio Interface output of a cellular phone which provides ground shorting when a call is received.
 - ④ **Remote Turn-On Lead (Blue/White)**
Connect this lead to the remote turn-on lead of your amplifier or signal processor.
 - ⑤ **Dimmer Lead (Orange)**
This lead may be connected to the vehicle's instrument cluster illumination lead. This will enable the vehicle's dimmer control to dim the backlighting of the unit.
 - ⑥ **Switched Power Lead (Ignition) (Red)**
Connect this lead to an open terminal on the vehicle's fuse box or another unused power source which provides (+) 12V only when the ignition is turned on or in the accessory position.
 - ⑦ **Ground Lead (Black)**
Connect this lead to a good chassis ground on the vehicle. Make sure the connection is made to bare metal and is securely fastened using the sheet metal screw provided.
 - ⑧ **Power Antenna Lead (Blue)**
Connect this lead to the +B terminal of your power antenna, if applicable.
- *This lead should be used only for controlling the vehicle's power antenna. Do not use this lead to turn on an amplifier or a signal processor, etc.*
- ⑨ **Battery Lead (Yellow)**
Connect this lead to the positive (+) post of the vehicle's battery.
 - ⑩ **ISO Power Supply Connector**
 - ⑪ **ISO Connector (Speaker Output)**
 - ⑫ **Left Rear (+) Speaker Output Lead (Green)**
 - ⑬ **Left Rear (-) Speaker Output Lead (Green/Black)**
 - ⑭ **Left Front (+) Speaker Output Lead (White)**
 - ⑮ **Left Front (-) Speaker Output Lead (White/Black)**
 - ⑯ **Right Front (-) Speaker Output Lead (Gray/Black)**
 - ⑰ **Right Front (+) Speaker Output Lead (Gray)**
 - ⑱ **Right Rear (-) Speaker Output Lead (Violet/Black)**
 - ⑲ **Right Rear (+) Speaker Output Lead (Violet)**
 - ⑳ **Steering Remote Control Interface Connector**
To steering remote control interface box.
 - ㉑ **Fuse Holder (10A)**
 - ㉒ **Front/Subwoofer* Output RCA Connectors**
- * *When Subwoofer is set to OFF: Output is from front speakers.
When Subwoofer is set to ON: Output is from Subwoofer.*
- RED is right and WHITE is left.
- ㉓ **Power Supply Connector**
 - ㉔ **RCA Extension Cable (Sold Separately)**
 - ㉕ **FULL SPEED™ Connection Cable (supplied)**
 - ㉖ **ISO/JASO Antenna Adapter (Sold Separately)**
An ISO/JASO antenna adapter may be required, depending on the vehicle.

To prevent noise/interference in the audio system.

- Locate the unit and route the leads at least 10 cm away from the car harness.
- Keep the battery power leads as far away from other leads as possible.
- Connect the ground lead securely to a bare metal spot (remove any paint, dirt or grease if necessary) of the car chassis.
- If you add an optional noise suppressor, connect it as far away from the unit as possible. Your Alpine dealer carries various noise suppressors, contact them for further information.
- Your Alpine dealer knows best about noise prevention measures so consult your dealer for further information.

Contents

Operating Instructions

WARNING

WARNING	3
CAUTION	3
PRECAUTIONS	3

Getting Started

Turning Power On and Off	6
Detaching and Attaching the Front Panel	6
Initial System Start-Up	7
Adjusting Volume	7

Radio

Listening to Radio	7
Manual Storing of Station Presets	7
Automatic Memory of Station Presets	8
Tuning to Preset Stations	8
Frequency Search Function	8

RDS

Setting RDS Reception Mode and Receiving RDS Stations	8
Recalling Preset RDS Stations	9
Receiving RDS Regional (Local) Stations	9
PI SEEK Setting	9
Setting PTY31 (Emergency Broadcast) reception	9
Receiving Traffic Information	10
PTY (Programme Type) Tuning	10
Receiving Traffic Information While Playing CD or Radio	10
Priority News	11
Displaying Radio Text	11

CD/MP3/WMA

Playback	11
Repeat Play	12
M.I.X. (Random Play)	12
Searching from CD Text	12

File/Folder Name Search (concerning MP3/WMA)	13
Quick Search	13
About MP3/WMA	13

Sound Setting

Adjusting Bass/Treble/Balance (Between Left and Right)/Fader (Between Front and Rear)/ Defeat	15
Setting the Bass Control	15
Setting the Treble Control	16
Turning Loudness On/Off	16

Other Functions

Displaying the Text	16
---------------------------	----

SETUP

Sound Customizing

Adjusting Source Signal Levels	18
Subwoofer On and Off	18
Setting the Subwoofer System	18

Visual Customizing

Changing Lighting Colour	18
Dimmer Control	18
Scroll Type Setting	18
Scroll Setting (TEXT SCROLL)	18
Demonstration	19

MP3/WMA

Playing MP3/WMA Data (PLAY MODE)	19
----------------------------------------	----

External Device

Connecting to an External Amplifier	19
-------------------------------------------	----

iPod™ (Optional)

Playback	20
Searching for a desired Song	20
Searching by Playlist	20
Searching by artist name	20
Searching by album name	21
Searching by Song name	21
Select Playlist/Artist/Album	21
Quick Search	22
Random Play Shuffle (M.I.X.)	22
Repeat Play	22
Displaying the Text	22



Information

In Case of Difficulty	23
Specifications	25

Installation and Connections

Warning	26
Caution	26
Precautions	26
Installation	27
Connections	28

Operating Instructions

WARNING



WARNING

This symbol means important instructions. Failure to heed them can result in serious injury or death.

DO NOT OPERATE ANY FUNCTION THAT TAKES YOUR ATTENTION AWAY FROM SAFELY DRIVING YOUR VEHICLE.

Any function that requires your prolonged attention should only be performed after coming to a complete stop. Always stop the vehicle in a safe location before performing these functions. Failure to do so may result in an accident.

KEEP THE VOLUME AT A LEVEL WHERE YOU CAN STILL HEAR OUTSIDE NOISE WHILE DRIVING.

Failure to do so may result in an accident.

DO NOT DISASSEMBLE OR ALTER.

Doing so may result in an accident, fire or electric shock.

USE ONLY IN CARS WITH A 12 VOLT NEGATIVE GROUND.

(Check with your dealer if you are not sure.) Failure to do so may result in fire, etc.

KEEP SMALL OBJECTS SUCH AS BATTERIES OUT OF THE REACH OF CHILDREN.

Swallowing them may result in serious injury. If swallowed, consult a physician immediately.

USE THE CORRECT AMPERE RATING WHEN REPLACING FUSES.

Failure to do so may result in fire or electric shock.

DO NOT BLOCK VENTS OR RADIATOR PANELS.

Doing so may cause heat to build up inside and may result in fire.

USE THIS PRODUCT FOR MOBILE 12V APPLICATIONS.

Use for other than its designed application may result in fire, electric shock or other injury.

DO NOT PLACE HANDS, FINGERS OR FOREIGN OBJECTS IN INSERTION SLOTS OR GAPS.

Doing so may result in personal injury or damage to the product.



CAUTION

This symbol means important instructions. Failure to heed them can result in injury or material property damage.

HALT USE IMMEDIATELY IF A PROBLEM APPEARS.

Failure to do so may cause personal injury or damage to the product. Return it to your authorized Alpine dealer or the nearest Alpine Service Centre for repairing.



PRECAUTIONS

Product Cleaning

Use a soft dry cloth for periodic cleaning of the product. For more severe stains, please dampen the cloth with water only. Anything else has the chance of dissolving the paint or damaging the plastic.

Temperature

Be sure the temperature inside the vehicle is between +60°C (+140°F) and -10°C (+14°F) before turning your unit on.

Moisture Condensation

You may notice the CD playback sound wavering due to condensation. If this happens, remove the disc from the player and wait about an hour for the moisture to evaporate.

Damaged Disc

Do not attempt to play cracked, warped, or damaged discs. Playing a bad disc could severely damage the playback mechanism.

Maintenance

If you have problems, do not attempt to repair the unit yourself. Return it to your Alpine dealer or the nearest Alpine Service Station for servicing.

Never Attempt the Following

Do not grip or pull out the disc while it is being pulled back into the player by the automatic reloading mechanism.

Do not attempt to insert a disc into the unit when the unit power is off.

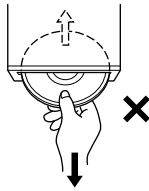

Inserting Discs

Your player accepts only one disc at a time for playback. Do not attempt to load more than one disc.

Make sure the label side is facing up when you insert the disc. "ERROR" will be displayed on your player if you insert a disc incorrectly. If "ERROR" continues to be displayed even though the disc has been inserted correctly, push the RESET switch with a pointed object such as a ballpoint pen.

Playing a disc while driving on a very bumpy road may result in skips, but this will not scratch the disc or damage the player.

New Discs

To prevent the CD from jamming, "ERROR" is displayed if discs with irregular surfaces are inserted or if discs are inserted incorrectly. When a new disc is ejected immediately after initial loading, use your finger to feel around the inside of the center hole and outside edge of the disc. If you feel any small bumps or irregularities, this could inhibit proper loading of the disc. To remove the bumps, rub the inside edge of the hole and outside edge of the disc with a ballpoint pen or other such instrument, then insert the disc again.

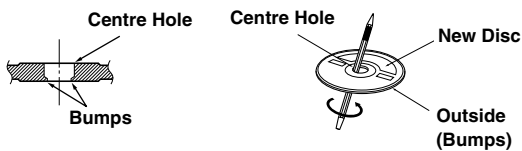

Irregular Shaped Discs

Be sure to use round shape discs only for this unit and never use any special shape discs.

Use of special shape discs may cause damage to the mechanism.



Installation Location

Make sure the CDE-9850Ri will not be installed in a location subjected to:

- Direct sun and heat
- High humidity and water
- Excessive dust
- Excessive vibrations

Correct Handling

Do not drop the disc while handling. Hold the disc so you will not leave fingerprints on the surface. Do not affix tape, paper, or gummed labels to the disc. Do not write on the disc.

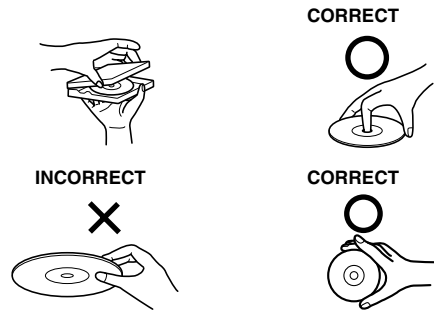

Disc Cleaning

Fingerprints, dust, or soil on the surface of the disc could cause the CD player to skip. For routine cleaning, wipe the playing surface with a clean, soft cloth from the centre of the disc to the outer edge. If the surface is heavily soiled, dampen a clean, soft cloth in a solution of mild neutral detergent before cleaning the disc.



Disc Accessories

There are various accessories available on the market for protecting the disc surface and improving sound quality. However, most of them will influence the thickness and/or diameter of the disc. Using such accessories can cause the disc to be out of standard specifications and may create operational problems. We recommend not using these accessories on discs played in Alpine CD players.

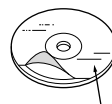

Transparent Sheet

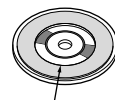

Disc Stabilizer

On handling Compact Discs (CD/CD-R/CD-RW)

- Do not touch the surface.
- Do not expose the disc to direct sunlight.
- Do not affix stickers or labels.
- Clean the disc when it is dusty.
- Make sure that there are no bumps around the disc.
- Do not use commercially available disc accessories.

Do not leave the disc in the car or the unit for a long time. Never expose the disc to direct sunlight. Heat and humidity may damage the CD and you may not be able to play it again.

To customers using CD-R/CD-RW

- If a CD-R/CD-RW cannot be played back, make sure the last recording session was closed (finalized).
- Finalize the CD-R/CD-RW if necessary, and attempt playback again.

About media that can be played.

Use only compact discs with the label side showing the CD logo marks below.



If you use unspecified compact discs, correct performance cannot be guaranteed.

You can play CD-Rs (CD-Recordable)/CD-RWs (CD-ReWritable) which have been recorded only on audio devices. You can also play CD-Rs/CD-RWs containing MP3/WMA formatted audio files.

- Some of the following CDs may not play on this unit:
Flawed CDs, CDs with fingerprints, CDs exposed to extreme temperatures or sunlight (e.g., left in the car or this unit), CDs recorded under unstable conditions, CDs on which a recording failed or a re-recording was attempted, copy-protected CDs which do not conform to the audio CD industry standard.
- Use discs with MP3/WMA files written in a format compatible with this unit. For details, see pages 13-14.
- ROM data other than audio files contained in a disc will not produce sound when played back.

-
- *Windows Media and the Windows logo are trademarks, or registered trademarks of Microsoft Corporation in the United States and/or other countries.*
 - *Apple, the Apple logo and iPod are trademarks of Apple Computer, Inc., registered in the U.S. and other countries.*
 - *“MPEG Layer-3 audio coding technology licensed from Fraunhofer IIS and Thomson.”*
 - *“Supply of this product only conveys a license for private, non-commercial use and does not convey a license nor imply any right to use this product in any commercial (i.e. revenue-generation) real time broadcasting (terrestrial, satellite, cable and/or any other media), broadcasting/streaming via internet, intranets and/or other networks or in other electronic content distribution systems, such as pay-audio or audio-on-demand applications. An independent license for such use is required. For details, please visit <http://www.mp3licensing.com>.”*

Getting Started

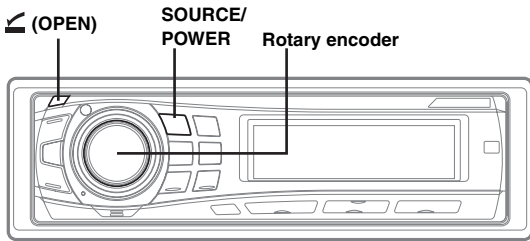

Turning Power On and Off

Press **SOURCE/POWER** to turn on the unit.

- The unit can be turned on by pressing any other button except (OPEN) and Rotary encoder.

Press and hold **SOURCE/POWER** for at least 2 seconds to turn off the unit.

- The first time power is turned on, the volume will start from level 12.

Detaching and Attaching the Front Panel

Be sure to push the Rotary encoder inside the unit before opening the front panel so that the front panel will open completely, otherwise it may be damaged.

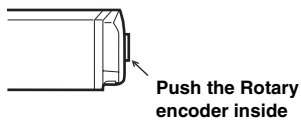

When you push the Rotary encoder again, it pops back out.

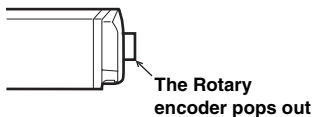

Detaching

- 1 Turn off the unit power.
- 2 Press (OPEN) to open the front panel.

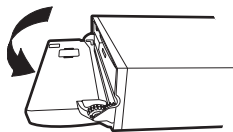

To close the front panel, press the left side until it locks as shown in the figure below.

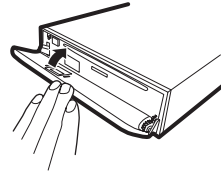

- 3 Grasp the front panel firmly, slide to the left ①, then pull ② to remove.

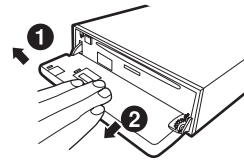

- The front panel may become hot in normal usage (especially the connector terminals on the back of the front panel.) This is not a malfunction.
- To protect the front panel, place it in the supplied carrying case.
- When detaching the front panel, do not apply excessive force as it may result in malfunction.
- Do not leave the front panel open, or drive the car with the panel open as it may result in accident or malfunction.

Attaching

- 1 Insert the right side of the front panel into the main unit. Align the groove on the front panel with the projections on the main unit.
- 2 Push the left side of the front panel until it locks firmly into the main unit.

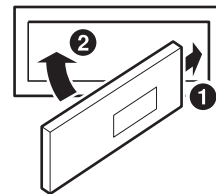

- Before attaching the front panel, make sure that there is no dirt or dust on the connector terminals and no foreign object between the front panel and the main unit.
- Attach the front panel carefully, holding the sides of the front panel to avoid pushing buttons by mistake.

Initial System Start-Up

Be sure to press the RESET switch when using the unit for the first time, after changing the car battery, etc.

- 1 Turn off the unit power.
- 2 Press  (OPEN) to open the front panel, then remove it.
- 3 Press **RESET** with a ballpoint pen or similar pointed object.

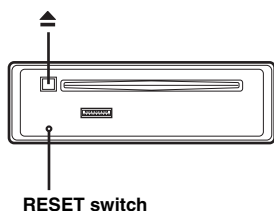

Adjusting Volume

Turn the **Rotary encoder** until the desired sound is obtained.

Controllable With Remote Control

The CDE-9850Ri can be controlled with an optional Alpine remote control. For details, consult your Alpine dealer. Point the optional remote control transmitter at the remote control sensor.

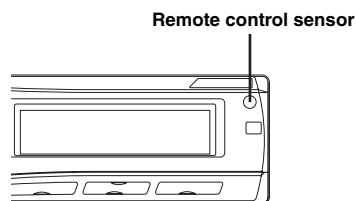

Connectable to Remote Control Interface Box

You can operate this unit from the vehicle's control unit when an Alpine Remote Control Interface Box (optional) is connected. For details, contact your Alpine dealer.

Radio

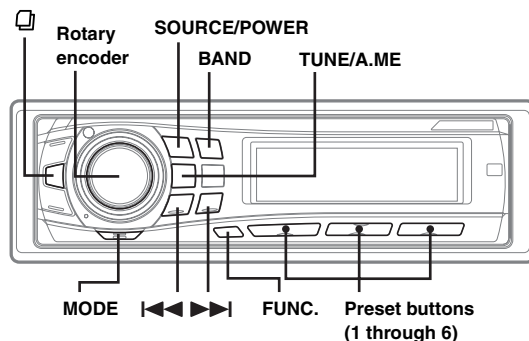

Listening to Radio

- 1 Press **SOURCE/POWER** until a radio frequency appears on the display.
- 2 Press **BAND** repeatedly until the desired radio band is displayed.

F1 (FM1) → F2 (FM2) → F3 (FM3) → MW → LW → F1 (FM1)

- 3 Press **TUNE/A.ME** to select the tuning mode.

DX SEEK (Distance mode) → SEEK (Local mode) → OFF (Manual mode) → DX SEEK

- The initial mode is Distance mode.

Distance mode:

Both strong and weak stations will be automatically tuned in (Automatic Seek Tuning).

Local mode:

Only strong stations will be automatically tuned in (Automatic Seek Tuning).

Manual mode:

The frequency is manually tuned in steps (Manual tuning).

- 4 Press  or  to tune in the desired station. Holding down  or  will change the frequency continuously.

Manual Storing of Station Presets

- 1 Select the radio band and tune in a desired radio station you wish to store in the preset memory.
- 2 Press and hold, for at least 2 seconds, any one of the **preset buttons (1 through 6)** into which you wish to store the station.

The selected station is stored.

The display shows the band, preset number and station frequency memorized.

- A total of 30 stations can be stored in the preset memory (6 stations for each band; FM1, FM2, FM3, MW and LW).
- If you store a station in a preset memory which already has a station, the current station will be cleared and replaced with the new station.
- If the "FUNC" indicator is illuminated, turn off the indicator by pressing **FUNC.**, then you can perform the operation.

Automatic Memory of Station Presets

- 1 Press **BAND** repeatedly until the desired radio band is displayed.
- 2 Press and hold **TUNE/A.ME** for at least 2 seconds. The frequency on the display continues to change while the automatic memory is in progress. The tuner will automatically seek and store 6 strong stations in the selected band. They will be stored into buttons 1 to 6 in order of signal strength. When the automatic memory has been completed, the tuner goes to the station stored in preset location No. 1.
 - If no stations are stored, the tuner will return to the original station you were listening to before the auto memory procedure began.

Tuning to Preset Stations

- 1 Press **BAND** repeatedly until the desired band is displayed.
- 2 Press any one of the station preset buttons (1 through 6) that has your desired radio station in memory. The display shows the band, preset number and frequency of the station selected.
 - If the "FUNC" indicator is illuminated, turn off the indicator by pressing **FUNC.**, then you can perform the operation.

Frequency Search Function

You can search for a radio station by its frequency.

- 1 Press and hold **□** for at least 2 seconds in Radio mode to activate Frequency Search mode.
 - 2 Turn the **Rotary encoder** to select the desired frequency.
 - 3 Press **MODE** to receive the selected frequency.
- Press and hold **□** for at least 2 seconds in the search mode to cancel. Or, the search mode will be cancelled when an operation has not been performed in 10 seconds.

RDS

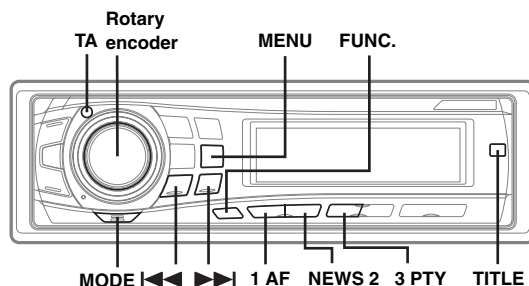

Setting RDS Reception Mode and Receiving RDS Stations

The RDS (Radio Data System) is a radio information system using the 57 kHz subcarrier of regular FM broadcast. The RDS allows you to receive a variety of information such as traffic information, station names, and to automatically re-tune to a stronger transmitter that is broadcasting the same programme.

- 1 Press **FUNC.** so that the "FUNC" indicator lights up.
 - 2 Press **1 AF** to activate the RDS mode.
 - 3 Press **◀◀** or **▶▶** to tune in the desired RDS station.
 - 4 Press **1 AF** again to deactivate the RDS mode.
 - 5 Press **FUNC.** to activate the normal mode. The "FUNC" indicator goes out.
- When the "Setting PTY31 (Emergency Broadcast) reception" (refer to page 9) is set to on, if the unit receives the PTY31 (Emergency Broadcast) signal, the unit will show "ALARM" in the display automatically.

The RDS digital data includes the following:

PI	Programme Identification
PS	Programme Service Name
AF	List of Alternative Frequencies
TP	Traffic Programme
TA	Traffic Announcement
PTY	Programme Type
EON	Enhanced Other Networks

Recalling Preset RDS Stations

- 1 Press FUNC.** so that the “FUNC” indicator lights up.
 - 2 Press 1 AF** to activate the RDS mode.
 - 3 Press FUNC.** to activate the normal mode.
The “FUNC” indicator goes out.
 - 4 Make sure that the “FUNC” indicator light goes out, then press the preset button in which your desired RDS station is preset.**
If the preset station's signal is weak, the unit automatically searches and tunes to a stronger station in the AF (Alternative Frequencies) list.
 - 5 If the preset station and the stations in the AF list cannot be received:**
When the PI SEEK setting is on (refer to “PI SEEK Setting” on page 9), the unit searches again for a station in the PI (Programme Identification) list.
If there are still no stations receivable in the area, the unit displays the frequency of the preset station and the preset number disappears.
If the signal level of the Regional (Local) station being tuned becomes too weak to receive, press the same preset button to tune in a Regional station in other district.
- *For presetting the RDS stations, refer to the Radio Operation section. The RDS stations can be preset in the F1, F2 and F3 bands only.*

Receiving RDS Regional (Local) Stations

- 1 Press MENU** to select the **SETUP** mode, then press **MODE**.
SETUP mode is activated.
BASS ENGINE → SETUP → RETURN (OFF) → BASS ENGINE
- 2 Press I◀◀ or ▶▶I** to select the **RDS REGIONAL** mode, then press **MODE**.
- 3 Turn the Rotary encoder** to select **ON** or **OFF**.
In the OFF mode, the unit automatically keeps receiving the related local RDS station.
- 4 Press MENU** to select **RETURN**.
After 2 seconds, the unit returns to normal mode.
Pressing and holding **MENU** for at least 2 seconds will return to normal mode.

PI SEEK Setting

- 1 Press MENU** to select the **SETUP** mode, then press **MODE**.
SETUP mode is activated.
BASS ENGINE → SETUP → RETURN (OFF) → BASS ENGINE
- 2 Press I◀◀ or ▶▶I** to select the **PI SEEK**, then press **MODE**.
- 3 Turn the Rotary encoder** to select **ON** or **OFF**.
- 4 Press MENU** to select **RETURN**.
After 2 seconds, the unit returns to normal mode.
Pressing and holding **MENU** for at least 2 seconds will return to normal mode.

Setting PTY31 (Emergency Broadcast) reception

Turn PTY31 (Emergency Broadcast) reception ON/OFF.

- 1 Press MENU** to select **SETUP** mode, then press **MODE**.
The SETUP mode is activated.
BASS ENGINE → SETUP → RETURN (OFF) → BASS ENGINE
- 2 Press I◀◀ or ▶▶I** to select **ALERT PTY31** mode, then press **MODE**.
- 3 Turn the Rotary encoder** to select **ON** or **OFF**.
If you set ON, emergency broadcast are received regardless of source. “ALARM” is displayed during reception.
- 4 Press MENU** to select **RETURN**.
After 2 seconds, the unit returns to normal mode.
Pressing and holding **MENU** for at least 2 seconds will return to normal mode.
When an emergency broadcast is received, the volume level will be automatically changed to the memorized level in the traffic information mode.
For details, refer to “Receiving Traffic Information.”

Receiving Traffic Information

- 1 Press **TA** so that the “TA” indicator lights up.
- 2 Press **◀◀** or **▶▶** to select your desired traffic information station.

When a traffic information station is tuned in, the “TP” indicator lights up.
Traffic information is heard only when it is being broadcast. If traffic information is not being broadcast, the unit is set in the standby mode. When a traffic information broadcast begins, the unit automatically receives it and the display shows “TRF-INFO” for a few seconds.
When the traffic information broadcast is over, the unit will automatically set in the standby mode.

- If the traffic information broadcast signal falls below a certain level, the unit remains in the receiving mode for 1 minute. If the signal remains below a certain level for over 1 minute, the “TA” indicator blinks.
- If you do not want to listen to the traffic information being received, lightly press **TA** to skip that traffic information message. The **TA** mode will remain in the **ON** position to receive the next traffic information message.
- If the volume level is changed while receiving traffic information, the changed volume level will be memorized. When traffic information is received next time, the volume level will be automatically adjusted to the level memorized.
- In the **TA** mode, the **SEEK** tuning selects only the **TP** stations.

PTY (Programme Type) Tuning

- 1 Press **FUNC.** so that the “FUNC” indicator lights up.
- 2 Press **3 PTY** to activate the **PTY** mode, while the unit is in **Radio (FM receiving)** mode.

The Programme Type of the station being currently received will be displayed for 10 seconds.
If there is no receivable **PTY** broadcast, “NO **PTY**” will be displayed for 10 seconds.
If no **RDS** station can be received, the display shows “NO **PTY**.”

- If no operation is performed within 10 seconds after pressing **3 PTY**, the **PTY** mode will be automatically cancelled.

- 3 Press **◀◀** or **▶▶** within 10 seconds after activating the **PTY** mode to choose the desired programme type while the **PTY (programme type)** is being displayed.

Each press scrolls the programme type by one.

[- LIGHT M ↔ CLASSICS ↔ OTHER M -]
[-----]

- 4 Press **3 PTY** within 10 seconds after selecting the programme type to start searching for a station in the selected programme type.

The chosen programme type display blinks during searching and lights when a station is found.

If no **PTY** station is found, “NO **PTY**” will be displayed for 10 seconds.

- 5 Press **FUNC.** to activate the normal mode.
The “FUNC” indicator goes out.

- Operate the unit while the “FUNC” indicator lights up. If no operation is performed within 10 seconds, the “FUNC” indicator goes out.

Receiving Traffic Information While Playing CD or Radio

- 1 Press **TA** so that the “TA” indicator lights up.
- 2 Press **◀◀** or **▶▶** to select a traffic information station if necessary.

When a traffic information broadcast starts, the unit automatically mutes the CD player or the regular FM broadcast.

When the traffic information broadcast finishes, the unit automatically returns to the original source play before the traffic information broadcast began.

When traffic information stations cannot be received:

In the tuner mode:

When the **TP** signal can no longer be received for over 1 minute, the “TA” indicator blinks.

In the CD mode:

When the **TP** signal can no longer be received, the traffic information station of another frequency will be selected automatically.

- The receiver is equipped with the **EON** (Enhanced Other Networks) function in order to keep track of additional alternate frequencies to the **AF** list. The “**EON**” indicator lights up while an **RDS EON** station is being received. If the station being received does not broadcast the traffic information, the receiver automatically tunes in the related station that broadcasts the traffic information when it occurs.

- 3 Press **TA** to deactivate the **Traffic Information** mode.
The “TA” indicator goes out.

Priority News

This function allows you to preset to give priority to the News programme. You will never miss the News programme as the unit automatically gives priority to the News programme whenever it begins broadcasting, and interrupts the programme you are currently listening. This feature is functional when your unit is set to a mode other than the MW and LW modes.

1 Press FUNC. so that the “FUNC” indicator lights up while the unit is in Radio (FM receiving) mode.

2 Press NEWS 2 to activate the PRIORITY NEWS mode. The “NEWS” indicator appears in the display.

To disable the PRIORITY NEWS function, press NEWS 2.

• In the PRIORITY NEWS function, unlike in the TA function, the volume does not increase automatically.

3 Press FUNC. to activate the normal mode, while the unit is in Radio (FM receiving) mode.

The “FUNC” indicator light goes out.

Displaying Radio Text

Text messages from a radio station can be displayed.

Press TITLE while receiving FM in the radio mode to select the Radio Text display.

The display will change every time the button is pressed.

If there is PS (Programme Service NAME):

PS (Programme Service Name)* → Radio Text → PS (Programme Service Name)

* Press and hold **TITLE** for at least 2 seconds if PS is displayed in the radio mode, “FREQUENCY” will be displayed for 5 seconds.

If there is no PS (Programme Service Name):

FREQUENCY → Radio Text → FREQUENCY

The display shows “WAITING” for a few seconds, then starts scrolling the text message.

• If there is no receivable text message or the unit cannot receive a text message properly, the display shows “NO TEXT.”

CD/MP3/WMA

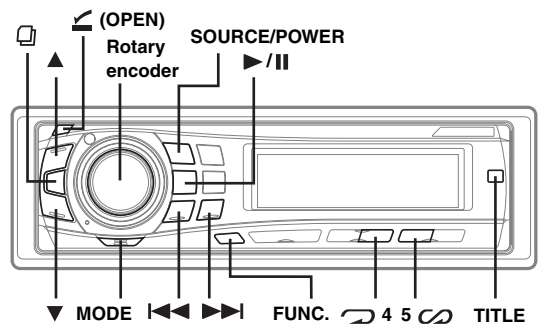

Playback

1 Press (OPEN).

The front panel will open.

2 Insert a disc with the label side facing up.

The disc will be pulled into the unit automatically.

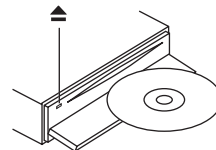

Close the front panel manually.

When a disc is already inserted, press **SOURCE/POWER** to switch to the CD mode.

The mode will change every time the button is pressed.

TUNER → DISC → IPOD* → TUNER

* Only when the iPod is connected.

3 While playing back MP3/WMA, press ▲ or ▼ to select the desired folder.

Pressing and holding ▲ or ▼ will change folders continuously.

4 Press ◀◀ or ▶▶ to select the desired track (file).

Returning to the beginning of the current track (file):

Press ◀◀.

Fast backward:

Press and hold ◀◀.

Advancing to the beginning of the next track (file):

Press ▶▶.

Fast forward:

Press and hold ▶▶.

5 To pause playback, press ▶/||.

Pressing ▶/|| again will resume playback.

6 After pressing **OPEN** to open the front panel, press **EJECT** to eject the disc.

- Do not remove a CD during its eject cycle. Do not load more than one disc at a time. A malfunction may result from doing either.
- If the CD does not eject, press and hold **EJECT** for at least 2 seconds.
- The CD-player can play discs containing audio data, MP3 data and WMA data.
- A WMA format file that is protected by DRM (Digital Rights Management) cannot be played back on this unit.
- The track display for MP3/WMA data playback is the file numbers recorded on the disc.
- The playback time may not be correctly displayed when a VBR (Variable Bit Rate) recorded file is played back.

MP3/WMA Play Display

The folder number and file number will be displayed as described below.

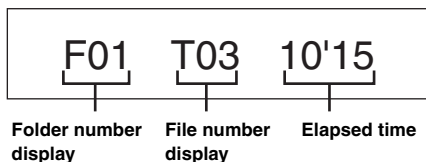

- Press **TITLE** to switch the display. See "Displaying the Text" (page 16) for information about display switching.
- If the folder number or file number is 3 digits, F or T becomes numbers of hundred rank.

Repeat Play

Press **REPEAT** 4 to play back repeatedly the track being played.

The track (file) will be played repeatedly.

Press **REPEAT** 4 again and select off to deactivate repeat play.

CD mode :

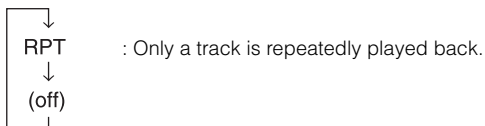

MP3/WMA mode :

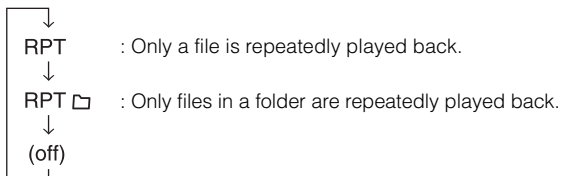

M.I.X. (Random Play)

Press **5** **MIX** in the play or pause mode.

The tracks (files) on the disc will be played back in random sequence.

To cancel M.I.X. play, press **5** **MIX** again.

CD mode :

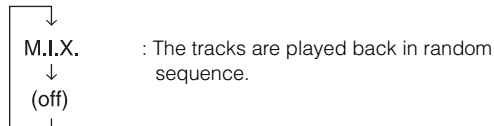

MP3/WMA mode :

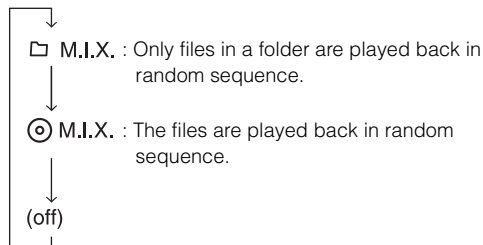

Searching from CD Text

Tracks can be searched and played by using the CD text on the disc. In the case of discs that do not support text, searches can be made by using the track numbers.

1 Press **SEARCH** during play.

This will set the search mode.



2 Turn the **Rotary encoder** to select the desired track, then press **MODE**.

This will play the selected track.



- Press and hold **SEARCH** for at least 2 seconds in the search mode to cancel. Or, the search mode will be cancelled when an operation has not been performed in 10 seconds.
- CD text search cannot be made during M.I.X. play.

File/Folder Name Search (concerning MP3/WMA)



You can display and search the folder and file name while listening to the file currently being played back.

- 1 Press  to activate Search selection mode during MP3/WMA playback.
- 2 Turn the Rotary encoder to select Folder Name Search mode or File Name Search mode, then press .

Folder Name Search mode

- 3 Turn the Rotary encoder to select the desired folder.
- 4 Press  to play back the first file in the selected folder.
 - Press and hold  for at least 2 seconds in the search mode to cancel. Or, the search mode will be cancelled when an operation has not been performed in 10 seconds.
 - While in Folder Name Search mode, press  to switch to File Name Search mode.
 - "ROOT" is displayed for the root folder which does not have folder name.
 - Folder Name search cannot be made during M.I.X. play.
 - Press **FUNC.** in the Search mode to return to the previous step.
 - Folder search cannot be performed if the disc only has root folder.
 - If there is no file in the folder when selecting the folder search mode, "NO FILE" will be displayed for 2 seconds.

File Name Search mode

- 3 Press  or  to select another Folder.
- 4 Select the desired file by turning the Rotary encoder.
- 5 Press **MODE** to playback the selected file.
 - Press and hold  for at least 2 seconds in the search mode to cancel. Or, the search mode will be cancelled when an operation has not been performed in 10 seconds.
 - File Name search cannot be made during M.I.X. play.
 - Press **FUNC.** in the Search mode to return to the previous step.

Quick Search

You can search for tracks (files).

- 1 Press and hold  for at least 2 seconds in the CD/MP3/WMA mode to activate Quick Search mode.
- 2 Turn the Rotary encoder to select a desired track (file).

The selected track is played back immediately.

 - Press and hold  for at least 2 seconds in the search mode to cancel. Or, the search mode will be cancelled when an operation has not been performed in 10 seconds.

About MP3/WMA

CAUTION

Except for private use, duplicating audio data (including MP3/WMA data) or distributing, transferring, or copying it, whether for free or for a fee, without permission of the copyright holder is strictly prohibited by the Copyright Act and by international treaty.

What is MP3?

MP3, whose official name is "MPEG-1 Audio Layer 3," is a compression standard prescribed by the ISO, the International Standardization Organization and MPEG which is a joint activity institution of the IEC.

MP3 files contain compressed audio data. MP3 encoding is capable of compressing audio data at extremely high ratios, reducing the size of music files to as much as one-tenth their original size. This is achieved while still maintaining near CD quality. The MP3 format realizes such high compression ratios by eliminating the sounds that are either inaudible to the human ear or masked by other sounds.

What is WMA?

WMA, or "Windows Media™ Audio," is compressed audio data. WMA is similar to MP3 audio data and can achieve CD quality sound with small file sizes.

Method for creating MP3/WMA files

Audio data is compressed by using MP3/WMA specified software. For details on creating MP3/WMA files, refer to the user's manual for that software. MP3/WMA files that can be played back by this device have the file extension "mp3" / "wma". Files with no extension cannot be played back. (WMA ver. 7.1, 8 and 9 are supported)

Supported playback sampling rates and bit rates

MP3

Sampling rates: 48 kHz, 44.1 kHz, 32 kHz, 24 kHz, 22.05 kHz, 16 kHz, 12 kHz, 11.025 kHz, 8 kHz

Bit rates: 8 - 320 kbps

WMA

Sampling rates: 48 kHz, 44.1 kHz, 32 kHz

Bit rates: 48 - 192 kbps

Note that for sampling rates, this device's frame display (page 16) may not display correctly.

This device may not play back correctly depending on sampling rates.

ID3 tags/WMA tags

This device supports ID3 tag v1 and v2, and WMA tag. If tag data is in an MP3/WMA file, this device can display the title (track title), artist name, and album name ID3 tag/WMA tag data.

This device can only display single-byte alphanumeric characters (up to 30 for ID3 tags and up to 15 for WMA tags) and the underscore. For non-supported characters, "NO SUPPORT" is displayed.

The tag information may not be correctly displayed, depending on the contents.

Producing MP3/WMA discs

MP3/WMA files are prepared, then written to a CD-R or CD-RW using CD-R writing software. A disc can hold up to 510 files/folders (including Root Folders). However, the maximum number of folders is 255.

Media supported

The media that this device can play back are CD-ROMs, CD-Rs, and CD-RWs.

Corresponding File Systems

This device supports discs formatted with ISO9660 Level 1 or Level 2.

Under the ISO9660 standard, there are some restrictions to remember.

The maximum nested folder depth is 8 (including the root directory). The number of characters for a folder/file name is limited.

Valid characters for folder/file names are letters A-Z (all caps), numbers 0-9, and '_' (underscore).

This device also can play back discs in Joliet, Romeo, etc., and other standards that conform to ISO9660. However, sometimes the file names, folder names, etc., are not displayed correctly.

Formats supported

This device supports CD-ROM XA, Mixed Mode CD, Enhanced CD (CD-Extra) and Multi-Session.

This device cannot correctly play back discs recorded with Track At Once or packet writing.

Order of files

The unit plays the files in the order that the writing software writes them. Therefore, the playing order may not be the same as the order you input. The playback order of the folders and files is as follows. However, the folder and file playback order differs from the folder and file number indicated on the display.

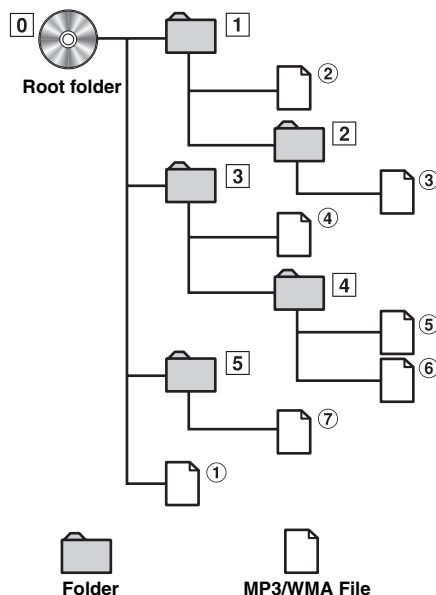

Terminology

Bit rate

This is the "sound" compression rate specified for encoding. The higher the bit rate, the higher the sound quality, but also the larger the files.

Sampling rate

This value shows how many times per second the data is sampled (recorded). For example, music CDs use a sampling rate of 44.1 kHz, so the sound is sampled (recorded) 44,100 times per second. The higher the sampling rate, the higher the sound quality, but also the larger the volume of data.

Encoding

Converting music CDs, WAVE (AIFF) files, and other sound files into the specified audio compression format.

Tag

Song information such as track titles, artist names, album names, etc., written into MP3/WMA files.

MP3: ID3 tag

WMA: WMA tag

Root folder

The root folder is found at the top of the file system. The root folder contains all folders and files.

Sound Setting

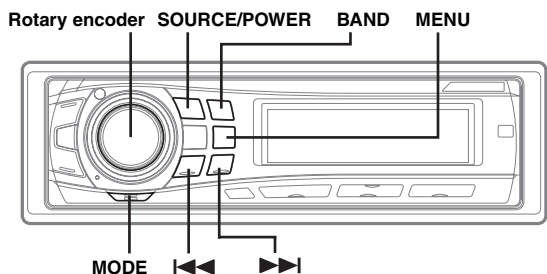

Adjusting Bass/Treble/Balance (Between Left and Right)/Fader (Between Front and Rear)/Defeat

1 Press **MODE** repeatedly to choose the desired mode.

Each press changes the mode as follows:

BASS → TREBLE → SUBW* → BALANCE → FADER → DEFEAT → VOLUME → BASS

Bass Level: -7 ~ +10

Treble Level: -7 ~ +7

Subwoofer : 0 ~ +15

Balance : L15 ~ R15

Fader : R15 ~ F15

Defeat : ON/OFF

Volume : 0 ~ 35

- If **MODE** is not pressed within 5 seconds after selecting the **BASS**, **TREBLE**, **BALANCE**, **FADER**, **DEFEAT** or **SUBW** mode, the unit automatically returns to normal mode.

* When the subwoofer mode is set to OFF, its level cannot be adjusted.

2 Turn the **Rotary encoder** until the desired sound is obtained in each mode.

By setting Defeat ON, previously adjusted settings of BASS and TREBLE will return to the factory defaults.

Setting the Bass Control

You can change the Bass Frequency emphasis to create your own tonal preference.

1 Press **MENU** to select the **BASS ENGINE** mode, then press **MODE**.

BASS ENGINE → SETUP → RETURN (OFF) → BASS ENGINE

2 Press **◀◀** or **▶▶** to select the **BASS** (bass Centre frequency) control mode.

BASS ↔ TREBLE

Setting the Bass Centre Frequency

3-1 Press **SOURCE/POWER** to select the desired bass centre frequency.

80Hz → 100Hz → 120Hz → 60Hz → 80Hz

Emphasize the displayed bass frequency ranges.

Setting the Bass Bandwidth

3-2 Press **BAND** to select the desired bass bandwidth.

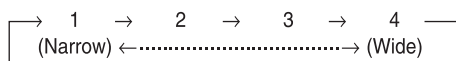

Change the boosted bass bandwidth to wide or narrow. A wide setting will boost a wide range of frequencies above and below the centre frequency. A narrower setting will boost only frequencies near the centre frequency.

Setting the Bass Level

3-3* Turn the **Rotary encoder** to select the desired bass level (-7~+10).

You can emphasize or weaken the bass level.

4 Press **MENU** to select **RETURN**.

After 2 seconds, the unit returns to normal mode.

Pressing and holding **MENU** for at least 2 seconds will return to normal mode.

- If no operation is performed within 60 seconds, the bass control setting will be turned off automatically.
 - The bass level settings will be individually memorized for each source (FM, MW (LW), CD, etc.) until the setting is changed. The bass frequency and bass band width settings adjusted for one source are effective for all other sources (FM, MW (LW), CD etc.).
 - Depending on the connected devices, some functions and display indications do not work. However, Bass Level is still adjustable if an audio processor with the Bass function is connected.
 - This function is inoperable when **DEFEAT** is set to ON.
 - If you press **◀◀** or **▶▶** in the bass control mode, the unit changes to the treble control mode.
- *1 The adjustment can also be made by pressing **MODE**. Refer to "Adjusting Bass/Treble/Balance (Between Left and Right)/Fader (Between Front and Rear)/Defeat" (page 15).

Bass level indicator's display

Bass level is usually displayed.

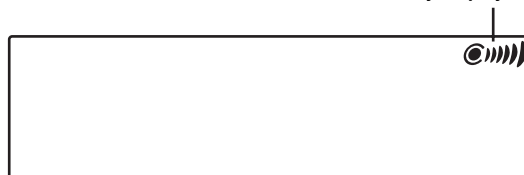

Setting the Treble Control

You can change the Treble Frequency emphasis to create your own tonal preference.

- 1 Press **MENU** to select the **BASS ENGINE** mode, then press **MODE**.

BASS ENGINE → SETUP → RETURN (OFF) → BASS ENGINE

- 2 Press **◀◀** or **▶▶** to select the **TREBLE** (Treble Centre Frequency) control mode.

BASS ↔ TREBLE

Setting the Treble Centre Frequency

- 3-1 Press **SOURCE/POWER** to select the desired treble Centre frequency.

10.0kHz → 12.5kHz → 15.0kHz → 7.5kHz → 10.0kHz

Emphasize the displayed treble frequency ranges.

Setting the Treble Level

- 3-2*² Turn the **Rotary encoder** to select the desired treble level (-7~+7).

You can emphasize the treble level.

- 4 Press **MENU** to select **RETURN**.

After 2 seconds, the unit returns to normal mode.

Pressing and holding **MENU** for at least 2 seconds will return to normal mode.

- If no operation is performed within 60 seconds, the treble control setting will be turned off automatically.
- The treble level settings will be individually memorized for each source (FM, MW (LW), CD, etc.) until the setting is changed. The Treble frequency settings adjusted for one source are effective for all other sources (FM, MW (LW), CD, etc.).
- Depending on the connected devices, some functions and display indications do not work. However, Treble Level is still adjustable if an audio processor with the Treble function is connected.
- This function is inoperable when **DEFEAT** is set to **ON**.
- If you press **◀◀** or **▶▶** in the treble control mode, the unit changes to the bass control mode.

*² The adjustment can also be made by pressing **MODE**. Refer to "Adjusting Bass/Treble/Balance (Between Left and Right)/Fader (Between Front and Rear)/Defeat" (page 15).

Turning Loudness On/Off

Loudness introduces a special low- and high-frequency emphasis at low listening levels. This compensates for the ear's decreased sensitivity to bass and treble sound.

Press and hold MODE for at least 2 seconds to activate or deactivate the loudness mode.

"LD" indicator lights.

Other Functions

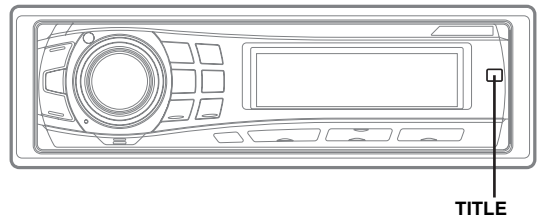

Displaying the Text

Text information, such as the disc name and the track name, will be displayed if playing a CD text compatible disc. It is also possible to display the folder name, the file name, and the tag, etc., while playing MP3/WMA files.

Press **TITLE**.

The display will change every time the button is pressed.

The display in Radio mode:

If there is PS (Programme Service NAME)

PS (Programme Service Name)*¹ → Radio Text →
PS (Programme Service Name)

If there is no PS (Programme Service Name)

FREQUENCY → Radio Text → FREQUENCY

The display in CD mode:

TRACK NO./ELAPSED TIME → TEXT (DISC NAME)*² →
TEXT (TRACK NAME)*² → TRACK NO./ELAPSED TIME

The display in MP3/WMA mode:

FOLDER NO./FILE NO./ELAPSED TIME → FOLDER NAME*³ →
FILE NAME*³ → ARTIST NAME*⁴ → ALBUM NAME*⁴ →
TRACK NAME*⁴ → FRAME*⁵ →
FOLDER NO./FILE NO./ELAPSED TIME

*¹ Press and hold **TITLE** for at least 2 seconds in the PS display mode, "FREQUENCY" will be displayed for 5 seconds.

*² Displayed during playback of a disc with CD Text.

If there is no Text (Disc Name or Track Name), "DISC TEXT"/
"TRACK TEXT" is displayed.

*³ "ROOT" is displayed for the folder name of the root folder which does not have folder name.

If there is no folder name or file name, "FOLDER"/"FILE" is displayed.

*⁴ ID3 tag/WMA tag

If an MP3/WMA file contains ID3 tag/WMA tag information, the ID3 tag/WMA tag information is displayed (track name, artist name, and album name). All other tag data is ignored.

If there is no tag information, "ARTIST"/"ALBUM"/"SONG" will be displayed.

If "SCROLL AUTO" is set in "Scroll Setting (TEXT SCROLL)" (page 18), tag information will automatically be scrolled.

*⁵ The recording sampling rate and bit rate of the MP3/WMA file are displayed. A WMA file of variable bit rate displays the average bit rate.

About the indication display

When displaying Text, the following indicators are lit according to the mode.

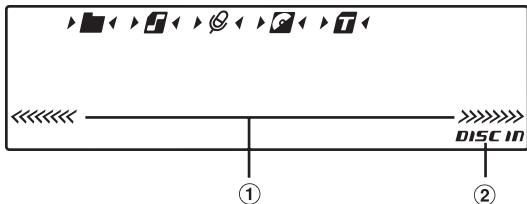

- ① The position of a song being played back is shown lit in the total number of songs shown. The display example is as shown below. Also lights up when operation, such as fast forward, etc., is performed.
- ② Lights up when a disc is inserted

Song position display example



- For example, when the 5th of 10 songs in the disc is played back, “<<<< >>>>” is displayed.

Indicator/ Mode	CD Mode	MP3/WMA Mode	iPod Mode
	—	While displaying Folder Name	—
	—	While displaying File Name	—
	—	While displaying Artist Name*	While displaying Artist Name*
	While displaying Text (Disc Name)	While displaying Album Name*	While displaying Album Name*
	While displaying Text (Track Name)	While displaying Track Name*	While displaying Track Name*

*Tag information

About “Text”

Text:

Text compatible CDs contain text information such as the disc name and track name. Such text information is referred to as “text.”

- Some characters may not be displayed correctly with this device, depending on the character type.
- When the Scroll Setting (page 18) is set to “SCROLL MANU,” press and hold **TITLE** for at least 2 seconds to scroll the Text information only once (TEXT DISPLAY, FOLDER NAME DISPLAY, FILE NAME DISPLAY or TAG DISPLAY mode).
- “NO SUPPORT” is displayed when the desired text information cannot be displayed on this unit.
- The text or tag information may not be correctly displayed, depending on the contents.

SETUP

You can flexibly customize the unit to suit your own preferences and usage. Choose the SETUP menu from Sound Customizing, Visual Customizing, etc., to select your desired setting.

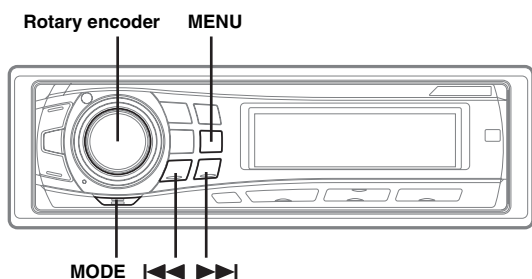

A typical SETUP procedure is shown in steps 1 to 4 as follows. See below for further information about each SETUP menu.

1 Press **MENU** to select the SETUP mode, then press **MODE**.

BASS ENGINE → SETUP → RETURN (OFF) → BASS ENGINE

2 Press **<<<** or **>>>** to select the desired SETUP menu, then press **MODE**.

(e.g. Select SUBWOOFER)

FM LEVEL ↔ RDS REGIONAL^{*1} ↔ PI SEEK^{*2} ↔
ALERT PTY31^{*3} ↔ ILLUMINATION ↔ DIMMER ↔
SUBWOOFER ↔ (SUBW SYSTEM)^{*4} ↔ PLAY MODE ↔
SCROLL TYPE ↔ TEXT SCROLL ↔ POWER IC ↔ DEMO ↔
FM LEVEL

^{*1} Refer to "Receiving RDS Regional (Local) Stations" (page 9)

^{*2} Refer to "PI SEEK Setting" (page 9)

^{*3} Refer to "Setting PTY31 (Emergency Broadcast) reception" (page 9)

^{*4} Displayed only when SUBW is ON.

3 Turn the **Rotary encoder** to change the setting.

(e.g. Select SUBW ON or SUBW OFF.)

4 Press **MENU** to select RETURN.

After 2 seconds, the unit returns to normal mode.

Pressing and holding **MENU** for at least 2 seconds will return to normal mode.

Sound Customizing

Adjusting Source Signal Levels

FM-LEVEL HI (Initial setting) / FM-LEVEL LOW

If the difference in volume level between the CD player and FM radio is too great, adjust the FM signal level.

Subwoofer On and Off

SUBW ON (Initial setting) / SUBW OFF

When the subwoofer is on, perform the steps below to adjust the subwoofer output level.

- 1 In the normal mode, press **MODE** repeatedly to select the SUBW mode.

BASS → TREBLE → SUBW → BALANCE → FADER →
DEFEAT → VOLUME → BASS

- 2 Adjust the level by turning the Rotary encoder.

Setting the Subwoofer System

SUBW SYS1 (Initial setting) / SUBW SYS2

Select either SYS1 or SYS2 for the desired subwoofer effect.

SUBW SYS1: Subwoofer level changes according to the main volume setting.

SUBW SYS2: Subwoofer level change is different from the main volume setting. For example, even at low volume settings, the subwoofer is still audible.

Visual Customizing

Changing Lighting Colour

ILLUMI BLUE (Initial setting) / RED

You can change the lighting colour of the buttons.

BLUE ↔ RED

Dimmer Control

DIMMER AUTO (Initial setting) / DIMMER MANU

Set the DIMMER control to AUTO to decrease the illumination brightness of the unit with the head lights of the vehicle ON. This mode is useful if you feel the unit's backlighting is too bright at night.

- If your vehicle should have a dimmer control for the dashboard lights, never connect the DIMMER cable (orange) of the radio to this dimmer control.

Scroll Type Setting

SCROLL TYPE1 / SCROLL TYPE2 (Initial setting)

Choose from two scrolling methods.

Select the type you prefer.

Scroll Setting (TEXT SCROLL)

SCROLL AUTO / SCROLL MANU (Initial setting)

This CD player can scroll the disc and track names recorded on CD-TEXT discs, as well as the text information of MP3/WMA files, folder names, and tags.

SCROLL AUTO: The CD text information, the text information of folder and file names, and the tags are scrolled automatically. Also, tag information is automatically scrolled without pressing TITLE in the tag information display mode.

SCROLL MANU: The display is scrolled when a disc is loaded or when a track is changed, etc.

- The unit scrolls CD text names, folder names, file names or tag display.

Demonstration

DEMO ON / DEMO OFF (Initial setting)

This unit has a demonstration feature for the display.

- To quit Demo mode, set to DEMO OFF.

MP3/WMA

Playing MP3/WMA Data (PLAY MODE)

CDDA (Initial setting) / CDDA/MP3

This product can playback CDs containing both CD and MP3/WMA data. However, in some situations (some enhanced CDs), playback may be difficult. For these special cases, you can select playback of CD data only. When a disc contains both CD or the MP3/WMA data, playback starts from the CD data portion of the disc.

- CDDA : Only CD data can be played back.
- CDDA/MP3 : Both CD data and MP3/WMA file tracks can be played back.

- Perform this setting before inserting a disc. If a disc has already been inserted, perform the setting after you remove the disc.

External Device

Connecting to an External Amplifier

POWER IC ON (Initial setting) / POWER IC OFF

When an external amplifier is connected, sound quality can be improved by stopping the power supply of the built-in amplifier.

POWER IC OFF : Use this mode when the front pre-amplifier of the unit is used to drive an external amplifier connected to the speakers. In this setting, the head unit's internal amplifier has no output to drive speakers.

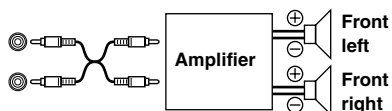

POWER IC ON : The speakers are driven by the built-in amplifier.

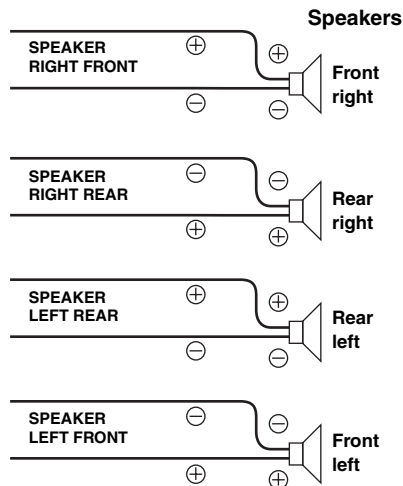

- No sound is produced by the system when the power output is set to OFF.

iPod™ (Optional)

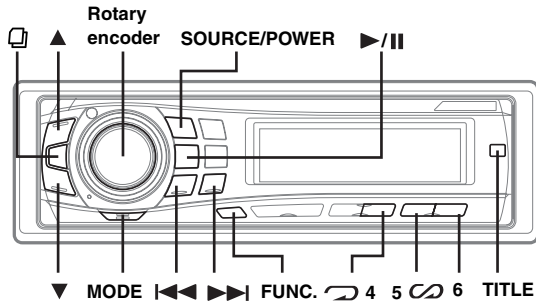

An iPod™, iPod™ mini or iPod™ nano can be connected to the CDE-9850Ri by using the FULL SPEED™ Connection Cable (supplied). When the CDE-9850Ri is connected by using the cable, the controls on the iPod™ are not functional.

About iPods™ usable with this unit

The unit can be used with third generation and above iPod™ photo, iPod™ minis or iPod™ nano. iPod™ Shuffle cannot be used, however.

- Touch wheel or scroll wheel type iPods without the dock connector cannot be connected to the unit.
- The unit can be used with the following iPod versions. Correct function of earlier versions cannot be guaranteed.

Third generation iPod: Ver. 2.3
Forth generation iPod: Ver. 3.0.2
iPod photo: Ver. 1.0
iPod mini: Ver. 1.3
iPod nano: Ver. 1.0

- The unit cannot be used with the software versions earlier than 22nd Feb.2005. For details about "iPod Software Update", refer to the iPod Instruction Manual.

Playback

- 1 Press **SOURCE/POWER** to switch to the iPod mode.
- 2 Press **<<<** or **>>>** to select the desired song.
Return to the beginning of the current song:
Press **<<<**.
Fast backward:
Press and hold **<<<**.
Advance to the beginning of the next song:
Press **>>>**.
Fast forward:
Press and hold **>>>**.

- 3 To pause playback, press **>/||**.
Pressing **>/||** again will resume playback.

- If a song is playing on the iPod when it is connected to the CDE-9850Ri, it will continue playing after the connection.

Searching for a desired Song

An iPod can contain hundreds of songs. By keeping these songs organized in playlists, the CDE-9850Ri can use these to ease song searches.

Searching by Playlist

- 1 Press **□** to activate the search selection mode.
- 2 Turn the **Rotary encoder** to select the **PLAYLIST** search mode, then press **□**.
PLAYLIST ↔ ARTIST ↔ ALBUM ↔ SONG ↔ PLAYLIST
- 3*1 Turn the **Rotary encoder** to select the desired Playlist.
- 4 Press **>/||**.
The selected playlist is played back.



To search for a song in the selected playlist

- 1 After selecting the playlist in step 3*1, press **□** to change to the song search mode of the selected playlist.
 - 2 Turn the **Rotary encoder** to select a song and press **MODE**.
The selected song is played back.
- Press and hold **□** for at least 2 seconds in the search mode to cancel. Or, the search mode will be canceled when an operation has not been performed in 10 seconds.
 - In the search mode, pressing **FUNC.** will return to the previous mode.
 - All songs in the iPod are played back by selecting the stored "iPod name" in step 3*1.
 - Playlist search cannot be made during M.I.X. play.
 - "NO SONG" will be displayed if there are no songs in the selected playlist in the PLAYLIST search mode.







Searching by artist name

- 1 Press **□** to activate the search selection mode.
- 2 Turn the **Rotary encoder** to select the **ARTIST** search mode, then press **□**.
PLAYLIST ↔ ARTIST ↔ ALBUM ↔ SONG ↔ PLAYLIST
- 3*2 Turn the **Rotary encoder** to select the desired Artist.
- 4 Press **>/||**.
All the songs of the selected Artist are played back.



To search for an album of the selected artist

- 1 After selecting the artist in step 3*², press  to change to the album search mode of the selected artist.
- 2*¹ Turn the Rotary encoder to select an album.
- 3 Press  to play back all songs of the selected album.

To search for a song of the selected album



- 1 After selecting the album in step 2*¹, press  to change to the song search mode of the selected album.
 - 2 Turn the Rotary encoder to select a song and press **MODE**.
The selected song is played back.
- Press and hold  for at least 2 seconds in the search mode to cancel. Or, the search mode will be canceled when an operation has not been performed in 10 seconds.
 - In the search mode, pressing **FUNC.** will return to the previous mode.
 - If you choose **ALL** in step 3*², and you press , all songs in iPod are played back. If you choose **ALL**, and you press , the **ALBUM** search mode for all artists is activated.
 - If you choose **ALL** in step 2*¹, and you press , all songs of the selected artist are played back. If you choose **ALL**, and you press , the **SONG** search mode for the selected artist is activated.
 - Artist name search cannot be made during **M.I.X.** play.

Searching by album name



- 1 Press  to activate the search selection mode.
- 2 Turn the Rotary encoder to select the **ALBUM** search mode, then press .
PLAYLIST ↔ ARTIST ↔ ALBUM ↔ SONG ↔ PLAYLIST
- 3*³ Turn the Rotary encoder to select the desired Album.
- 4 Press .
All the songs of the selected Albums are played back.

To search for a song of the selected album

- 1 After selecting the album in step 3*³, press  to change to the song search mode of the selected album.
- 2 Turn the Rotary encoder to select a song and press **MODE**.
The selected song is played back.

- Press and hold  for at least 2 seconds in the search mode to cancel. Or, the search mode will be canceled when an operation has not been performed in 10 seconds.
- In the search mode, pressing **FUNC.** will return to the previous mode.
- If you choose **ALL** in step 3*³, and you press , All songs in iPod are played back. If you choose **ALL**, and you press , the **SONG** search mode for all albums is activated.
- Album name search cannot be made during **M.I.X.** play.



Searching by Song name

- 1 Press  to activate search selection mode.
 - 2 Turn the Rotary encoder to select the **SONG** search mode, then Press .
PLAYLIST ↔ ARTIST ↔ ALBUM ↔ SONG ↔ PLAYLIST
 - 3 Turn the Rotary encoder to select the desired Song.
 - 4 Press **MODE**.
The selected song is played back.
- Press and hold  for at least 2 seconds in the search mode to cancel. Or, the search mode will be canceled when an operation has not been performed in 10 seconds.
 - In the search mode, pressing **FUNC.** will return to the previous mode.
 - Song name search cannot be made during **M.I.X.** play.

Select Playlist/Artist/Album

Playlist/Artist/Album can be easily changed.

For example, if you listen to a song from a selected album, the album can be changed.

- 1 Press  or  to select the desired Playlist/Artist/Album.
- If search selection mode is not activated, only Song is searched, this operation is not possible.
 - If an album is selected from an artist search, the album can be searched.
 - During shuffle (**M.I.X.**) playback, this operation is not possible.

Quick Search

You can search for songs.

1 Press and hold  for at least 2 seconds to activate Quick Search mode.

2 Turn the Rotary encoder to select a desired song.
The selected song is played back immediately.

- Press and hold  for at least 2 seconds in the search mode to cancel. Or, the search mode will be canceled when an operation has not been performed in 10 seconds.
- If many songs are in the iPod, it takes time to search for songs.

Random Play Shuffle (M.I.X.)

The Shuffle function of the iPod is displayed as M.I.X. on the CDE-9850Ri.

Shuffle Albums:

Album shuffle playback plays back all songs in order, then randomly selects the next album. All songs of that album are played back in order, and so on. Any one album is played just once.

Shuffle Songs:

Song shuffle randomly plays back certain selected songs. Any one song plays back just once until all songs have been played back.

1 Press 5 .

The songs will be played back in random sequence.

 M.I.X. → M.I.X. → (off) →  M.I.X.
(Shuffle Albums) (Shuffle Songs)

2 To cancel M.I.X. play, select (off) with the above procedure.

- For details of the search mode, refer to “Searching for a desired Song” (page 20).
- If a song is selected in the album search mode before selecting Shuffle (M.I.X.), the songs will not play back randomly even when Shuffle album is selected.

Shuffle ALL:

Shuffle ALL plays all songs in the iPod randomly. Any one song does not play back again until all songs have been played back.

1 Press 6.

The songs will be played back in random sequence.

M.I.X. → (off) → M.I.X.
(Shuffle ALL)

2 To cancel M.I.X. play, select (off) with the above procedure.

- If Shuffle All is selected, the selected ones which being played back in the search mode are cancelled.

Repeat Play

Only Repeat One is available for the iPod.



Repeat One: A single song is repeatedly played back.

1 Press  4.

The file will be played repeatedly.

RPT → (off) → RPT
(Repeat One)

2 To cancel repeat play, select (off) with the above procedure.

- During repeat playback, no other songs are selectable by pressing  or .

Displaying the Text

You can display the tag information of a song in the iPod.

Press TITLE.

Each press changes the display.

TRACK NO./ELAPSED TIME → ARTIST NAME* →
ALBUM NAME* → SONG TITLE* → TRACK NO./ELAPSED
TIME

* TAG information

If the Scroll setting (page 18) is set to “SCROLL AUTO,” the tag information will scroll automatically.

“ARTIST”/“ALBUM”/“SONG” is displayed if there is no tag information.

- When the Scroll Setting (page 18) is set to “SCROLL MANU,” press and hold **TITLE** for at least 2 seconds to scroll the tag information only once.
- Only alphanumeric characters (ASCII) can be displayed.
- If the artist, album or song name, created in iTunes, has too many characters, songs may not be played back when connected to the adapter. Therefore, a maximum of 250 characters is recommended. The maximum number of characters for the head unit is 128 (128 byte).
- Some characters may not be correctly displayed.
- “NO SUPPORT” is displayed when text information is not compatible with the CDE-9850Ri.

Information

In Case of Difficulty

If you encounter a problem, please turn the power off, then on again. If the unit is still not functioning normally, please review the items in the following checklist. This guide will help you isolate the problem if the unit is at fault. Otherwise, make sure the rest of your system is properly connected or consult your authorized Alpine dealer.

Basic

No function or display.

- Vehicle's ignition is off.
 - If connected following instructions, the unit will not operate with the vehicle's ignition off.
- Improper power lead (Red) and battery lead (Yellow) connections.
 - Check power lead and battery lead connections.
- Blown fuse.
 - Check the fuse of the unit; replace with the proper value if necessary.
- Internal micro-computer malfunctioned due to interference noise etc.
 - Press the RESET switch with a ballpoint pen or other pointed article.

Radio

Unable to receive stations.

- No antenna or open connection in cable.
 - Make sure the antenna is properly connected; replace the antenna or cable if necessary.

Unable to tune stations in the seek mode.

- You are in a weak signal area.
 - Make sure the tuner is in the DX mode.
- If the area you are in is a primary signal area, the antenna may not be grounded and connected properly.
 - Check your antenna connections; make sure the antenna is properly grounded at its mounting location.
- The antenna may not be the proper length.
 - Make sure the antenna is fully extended; if broken, replace the antenna with a new one.

Broadcast is noisy.

- The antenna is not the proper length.
 - Extend the antenna fully; replace it if it is broken.
- The antenna is poorly grounded.
 - Make sure the antenna is grounded properly at its mounting location.

CD

CD Player not functioning.

- Out of operating temperature range +50°C (+120°F) for CD.
 - Allow the vehicle's interior (or trunk) temperature to cool.

CD playback sound is wavering.

- Moisture condensation in the CD Module.
 - Allow enough time for the condensation to evaporate (about 1 hour).

CD insertion not possible.

- A CD is already in the CD player.
 - Eject the CD and remove it.
- The CD is being improperly inserted.
 - Make sure the CD is being inserted following instructions in the CD Player Operation section.

Unable to fast forward or backward the CD.

- The CD has been damaged.
 - Eject the CD and discard it; using a damaged CD in your unit can cause damage to the mechanism.

CD playback sound skips due to vibration.

- Improper mounting of the unit.
 - Securely re-mount the unit.
- The disc is very dirty.
 - Clean the disc.
- The disc has scratches.
 - Change the disc.
- The pick-up lens is dirty.
 - Do not use a commercial available lens cleaner disc. Consult your nearest Alpine dealer.

CD playback sound skips without vibration.

- The disc is dirty or scratched.
 - Clean the disc; damaged disc should be replaced.

Error displays

- Mechanical error
 - Press . After the error indication disappears, insert the disc again. If the above-mentioned solution does not solve the problem, consult your nearest Alpine dealer.

CD-R/CD-RW playback not possible

- Close session (finalization) has not been performed.
 - Perform finalization and attempt playback again.

MP3/WMA

MP3 or WMA is not played back.

- Writing error occurred. The CD format is not compatible.
 - Make sure the CD has been written in a supported format. Refer to "About MP3/WMA" (page 13-14), then rewrite in the format supported by this device.

Audio

The sound is not output from the speakers.

- Unit has no output signal of the internal amplifier.
 - POWER IC is switched to "ON" (page 19).

Indication for CD Player

HI TEMP

- Protective circuit is activated due to high temperature.
 - The indication will disappear when the temperature returns to normal operating range.
-

NO DISC

- No CD is inserted.
 - Insert a CD.
 - Although a disc is inserted, "NO DISC" is displayed and the unit does not start to play or eject the disc.
 - Remove the disc by following these steps:
 - Press the **▲** button again for at least 2 seconds.
 - If the disc still does not eject, consult your Alpine dealer.
-

ERROR

- Mechanism error.
 - 1) Press the **▲** button and eject the CD.
 - If not ejecting, consult your Alpine dealer.
 - 2) When the error indication remains after ejecting, press the **▲** button again.
 - If the error indication still does not turn off after pressing the **▲** button for a few times, consult your Alpine dealer.
 - When "ERROR" is displayed:
 - If that the disc cannot be ejected by pressing **▲**, press the **RESET** switch (refer to page 7) and press **▲** again.
 - If the disc still cannot be ejected, consult your Alpine dealer.
-

PROTECT

- A copy-protected WMA file was played back.
 - You can only play back non-copy-protected files.
-

UNSUPPORTED

- The disc is not written in a MP3/WMA supported format.
 - Use a disc written at the MP3/WMA supported format.
-

Indication for iPod Mode

NO IPOD

- The iPod is not connected.
 - Make sure the iPod is correctly connected (refer to "Connections").
 - Make sure the cable is not bent excessively.
 - The iPod's battery remains low.
 - Refer to the iPod's documentation and charge the battery.
-

NO SONG

- There are no songs in the iPod.
 - Download songs to the iPod and connect to the adapter.
-

ERROR-01

- Communication error
 - Turn the ignition key off, and then set to ON again.
 - Check the display by reconnecting between the iPod and the adapter, using the iPod cable.
-

ERROR-02

- Caused by the iPod Software Version not being compatible with the unit.
 - Update the iPod Software Version to be compatible with the unit.
-

Specifications

FM TUNER SECTION

Tuning Range	87.5 – 108.0 MHz
Mono Usable Sensitivity	0.7 μ V
Alternate Channel Selectivity	80 dB
Signal-to-Noise Ratio	65 dB
Stereo Separation	35 dB
Capture Ratio	2.0 dB

MW TUNER SECTION

Tuning Range	531 – 1,602 kHz
Sensitivity (IEC Standard)	25.1 μ V/28 dB

LW TUNER SECTION

Tuning Range	153 – 281 kHz
Sensitivity (IEC Standard)	31.6 μ V/30 dB

CD SECTION

Frequency Response	5 – 20,000 Hz (\pm 1 dB)
Wow & Flutter (% WRMS)	Below measurable limits
Total Harmonic Distortion	0.008% (at 1 kHz)
Dynamic Range	95 dB (at 1 kHz)
Signal-to-Noise Ratio	105 dB
Channel Separation	85 dB (at 1 kHz)

PICKUP

Wave length	795 nm
Laser power	CLASS I

GENERAL

Power Requirement	14.4 V DC (11–16 V allowable)
Maximum Power Output	50 W \times 4
Maximum Pre-Output Voltage	2 V/10k ohms
Bass	+20/-14dB at 60Hz
Treble	\pm 14dB at 10kHz
Weight	1.6 kg (3 lbs. 8 oz)

CHASSIS SIZE

Width	178 mm (7")
Height	50 mm (2")
Depth	162 mm (6-3/8")

NOSEPIECE SIZE

Width	170 mm (6-11/16")
Height	46 mm (1-13/16")
Depth	24 mm (15/16")

- Due to continuous product improvement, specifications and design are subject to change without notice.

CAUTION



(Bottom side of player)

Installation and Connections

Before installing or connecting the unit, please read the following and pages 3 and 5 of this manual thoroughly for proper use.

Warning

MAKE THE CORRECT CONNECTIONS.

Failure to make the proper connections may result in fire or product damage.

USE ONLY IN CARS WITH A 12 VOLT NEGATIVE GROUND.

(Check with your dealer if you are not sure.) Failure to do so may result in fire, etc.

BEFORE WIRING, DISCONNECT THE CABLE FROM THE NEGATIVE BATTERY TERMINAL.

Failure to do so may result in electric shock or injury due to electrical shorts.

DO NOT SPLICE INTO ELECTRICAL CABLES.

Never cut away cable insulation to supply power to other equipment. Doing so will exceed the current carrying capacity of the wire and result in fire or electric shock.

DO NOT DAMAGE PIPE OR WIRING WHEN DRILLING HOLES.

When drilling holes in the chassis for installation, take precautions so as not to contact, damage or obstruct pipes, fuel lines, tanks or electrical wiring. Failure to take such precautions may result in fire.

DO NOT USE BOLTS OR NUTS IN THE BRAKE OR STEERING SYSTEMS TO MAKE GROUND CONNECTIONS.

Bolts or nuts used for the brake or steering systems (or any other safety-related system), or tanks should NEVER be used for installations or ground connections. Using such parts could disable control of the vehicle and cause fire etc.

KEEP SMALL OBJECTS SUCH AS BATTERIES OUT OF THE REACH OF CHILDREN.

Swallowing them may result in serious injury. If swallowed, consult a physician immediately.

DO NOT INSTALL IN LOCATIONS WHICH MIGHT HINDER VEHICLE OPERATION, SUCH AS THE STEERING WHEEL OR SHIFT LEVER.

Doing so may obstruct forward vision or hamper movement etc. and results in serious accident.

Caution

HAVE THE WIRING AND INSTALLATION DONE BY EXPERTS.

The wiring and installation of this unit requires special technical skill and experience. To ensure safety, always contact the dealer where you purchased this product to have the work done.

USE SPECIFIED ACCESSORY PARTS AND INSTALL THEM SECURELY.

Be sure to use only the specified accessory parts. Use of other than designated parts may damage this unit internally or may not securely install the unit in place. This may cause parts to become loose resulting in hazards or product failure.

ARRANGE THE WIRING SO IT IS NOT CRIMPED OR PINCHED BY A SHARP METAL EDGE.

Route the cables and wiring away from moving parts (like the seat rails) or sharp or pointed edges. This will prevent crimping and damage to the wiring. If wiring passes through a hole in metal, use a rubber grommet to prevent the wire's insulation from being cut by the metal edge of the hole.

DO NOT INSTALL IN LOCATIONS WITH HIGH MOISTURE OR DUST.

Avoid installing the unit in locations with high incidence of moisture or dust. Moisture or dust that penetrates into this unit may result in product failure.

Precautions

- Be sure to disconnect the cable from the (-) battery post before installing your CDE-9850Ri. This will reduce any chance of damage to the unit in case of a short-circuit.
- Be sure to connect the colour coded leads according to the diagram. Incorrect connections may cause the unit to malfunction or damage to the vehicle's electrical system.
- When making connections to the vehicle's electrical system, be aware of the factory installed components (e.g. on-board computer). Do not tap into these leads to provide power for this unit. When connecting the CDE-9850Ri to the fuse box, make sure the fuse for the intended circuit of the CDE-9850Ri has the appropriate amperage. Failure to do so may result in damage to the unit and/or the vehicle. When in doubt, consult your Alpine dealer.
- The CDE-9850Ri uses female RCA-type jacks for connection to other units (e.g. amplifier) having RCA connectors. You may need an adaptor to connect other units. If so, please contact your authorized Alpine dealer for assistance.
- Be sure to connect the speaker (-) leads to the speaker (-) terminal. Never connect left and right channel speaker cables to each other or to the vehicle body.

IMPORTANT

Please record the serial number of your unit in the space provided below and keep it as a permanent record. The serial number or the engraved serial number is located on the bottom of the unit.

SERIAL NUMBER: _____

INSTALLATION DATE: _____

INSTALLATION TECHNICIAN: _____

PLACE OF PURCHASE: _____

Installation

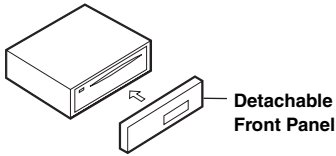

Caution

When you install this unit in your car, do not remove the detachable front panel. If the detachable front panel is removed during installation, you might press too hard and warp the metal plate that holds it in place.

Accessory List

- Head unit1
 - Power cable.....1
 - FULL SPEED™ Connection Cable.....1
 - Mounting sleeve.....1
 - Carrying case.....1
 - Rubber Cap1
 - Hex Bolt1
 - Screw (M5 × 8).....4
 - Owner's Manual 1 set
- The main unit must be mounted within 35 degrees of the horizontal plane, back to front.

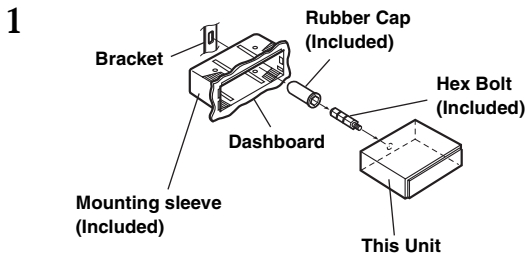
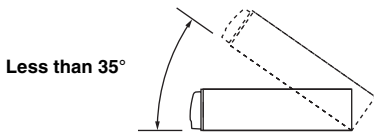

Slide mounting sleeve from main unit (see "Removal" on page 27). Slide the mounting sleeve into the dashboard and fix it with the metal shackles.

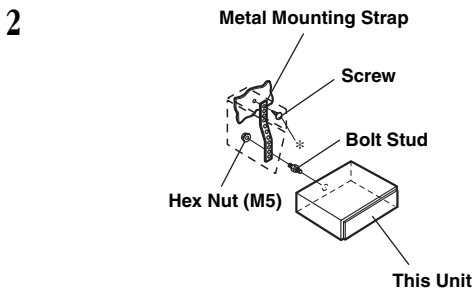

When your vehicle has the Bracket, mount the long hex bolt onto the rear panel of the CDE-9850Ri and put the Rubber Cap on the hex bolt. If your vehicle does not have the Mounting Support, reinforce the head unit with the metal mounting strap (not supplied). Connect all the leads of the CDE-9850Ri according to details described in the CONNECTION section.

- For the screw *, provide a proper screw to the chassis installing location.

- 3** Slide the CDE-9850Ri into the dashboard. When the unit is in place, make sure the locking pins are fully seated in the down position. This can be done by pressing firmly in on the unit while pushing the locking pin down with a small screwdriver. This ensures that the unit is properly locked and will not accidentally come out from the dashboard. Install the Detachable Front Panel.

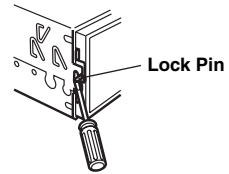

Removal

1. Remove the detachable front panel.
2. Use a small screwdriver (or similar tool) to push the locking pins to the "up" position (see above drawing). As each pin is unlocked, gently pull out on the unit to make sure it does not re-lock before unlocking the second pin.
3. Pull the unit out, keeping it unlocked as you do so.

<JAPANESE CAR>

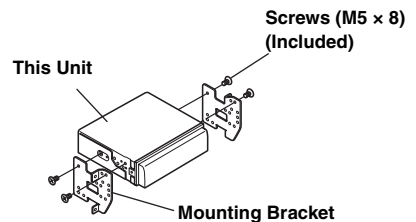
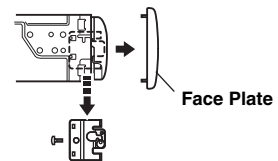

Connections

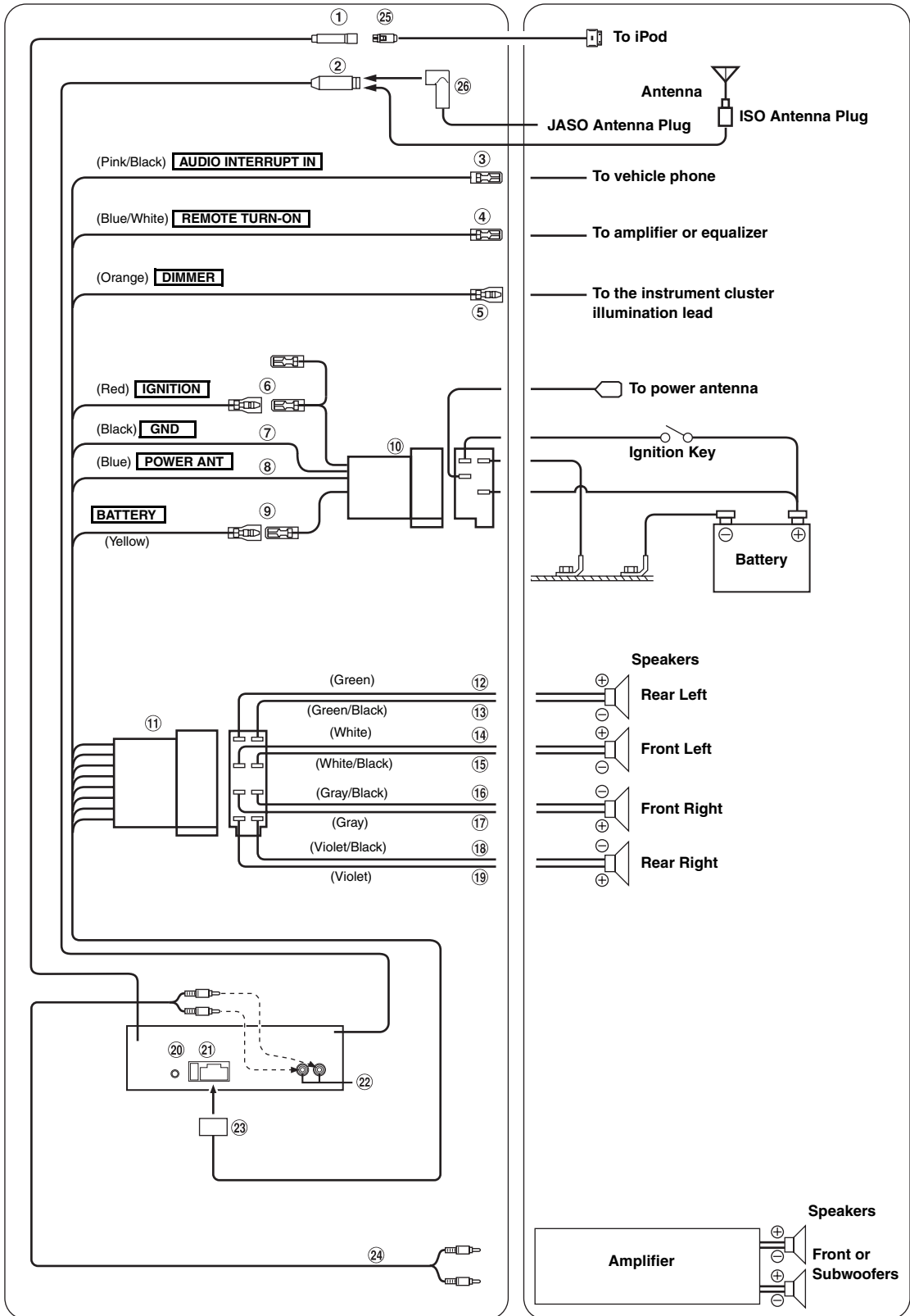

- ① **iPod Direct Connector**
iPod control signals.
Connect this to an iPod, using the FULL SPEED™ Connection Cable (supplied).
 - ② **Antenna Receptacle**
 - ③ **Audio Interrupt In Lead (Pink/Black)**
Connect this lead to the Audio Interface output of a cellular phone which provides ground shorting when a call is received.
 - ④ **Remote Turn-On Lead (Blue/White)**
Connect this lead to the remote turn-on lead of your amplifier or signal processor.
 - ⑤ **Dimmer Lead (Orange)**
This lead may be connected to the vehicle's instrument cluster illumination lead. This will enable the vehicle's dimmer control to dim the backlighting of the unit.
 - ⑥ **Switched Power Lead (Ignition) (Red)**
Connect this lead to an open terminal on the vehicle's fuse box or another unused power source which provides (+) 12V only when the ignition is turned on or in the accessory position.
 - ⑦ **Ground Lead (Black)**
Connect this lead to a good chassis ground on the vehicle. Make sure the connection is made to bare metal and is securely fastened using the sheet metal screw provided.
 - ⑧ **Power Antenna Lead (Blue)**
Connect this lead to the +B terminal of your power antenna, if applicable.
- *This lead should be used only for controlling the vehicle's power antenna. Do not use this lead to turn on an amplifier or a signal processor, etc.*
- ⑨ **Battery Lead (Yellow)**
Connect this lead to the positive (+) post of the vehicle's battery.
 - ⑩ **ISO Power Supply Connector**
 - ⑪ **ISO Connector (Speaker Output)**
 - ⑫ **Left Rear (+) Speaker Output Lead (Green)**
 - ⑬ **Left Rear (-) Speaker Output Lead (Green/Black)**
 - ⑭ **Left Front (+) Speaker Output Lead (White)**
 - ⑮ **Left Front (-) Speaker Output Lead (White/Black)**
 - ⑯ **Right Front (-) Speaker Output Lead (Gray/Black)**
 - ⑰ **Right Front (+) Speaker Output Lead (Gray)**
 - ⑱ **Right Rear (-) Speaker Output Lead (Violet/Black)**
 - ⑲ **Right Rear (+) Speaker Output Lead (Violet)**
 - ⑳ **Steering Remote Control Interface Connector**
To steering remote control interface box.
 - ㉑ **Fuse Holder (10A)**
 - ㉒ **Front/Subwoofer* Output RCA Connectors**
- * *When Subwoofer is set to OFF: Output is from front speakers.
When Subwoofer is set to ON: Output is from Subwoofer.*
- RED is right and WHITE is left.
- ㉓ **Power Supply Connector**
 - ㉔ **RCA Extension Cable (Sold Separately)**
 - ㉕ **FULL SPEED™ Connection Cable (supplied)**
 - ㉖ **ISO/JASO Antenna Adapter (Sold Separately)**
An ISO/JASO antenna adapter may be required, depending on the vehicle.

To prevent noise/interference in the audio system.

- Locate the unit and route the leads at least 10 cm away from the car harness.
- Keep the battery power leads as far away from other leads as possible.
- Connect the ground lead securely to a bare metal spot (remove any paint, dirt or grease if necessary) of the car chassis.
- If you add an optional noise suppressor, connect it as far away from the unit as possible. Your Alpine dealer carries various noise suppressors, contact them for further information.
- Your Alpine dealer knows best about noise prevention measures so consult your dealer for further information.

Appendix

Product Information Card

Produkt-Informationskarte

Carte d'informations sur le produit

Tarjeta de información del producto

English

Filling in this Product Information Card is voluntary. If you fill in this card and send it to Alpine, your data will be tabulated into reference data for future Alpine product development. In addition, in the future you may receive information about new products or Survey Mail requesting additional opinions about Alpine products or services. If you agree to the above term, please sign your name in the indicated space and return the card. Any additional comments or inquiries may be sent to: Person in charge of Customer Service department Alpine Electronics (Europe) GmbH.
Frankfurter Ring 117, 80807 München, Germany
Phone: +49-(0)89-32 42 640

Deutsch

Das Ausfüllen dieser Produktinformations-Karte ist freiwillig. Sollten Sie diese Karte vervollständigen, so werden die Daten für zukünftige Produktentwicklungen von Alpine als Referenzdaten herangezogen. Ebenso können Sie in der Zukunft Informationen über neue Alpine Produkte erhalten oder uns auch Ihre Meinung über Alpine Produkte und Dienstleistungen im Rahmen von Kunden-Befragungen mitteilen. Stimmen Sie dem Kontakt durch Alpine zu, so würden wir Sie bitten, in dem dafür vorgesehenen Feld zu unterschreiben und die Karte kostenfrei an uns zurückzuschicken. Zusätzliche Kommentare und Meinungen können Sie gerne an den zuständigen Kontakt im Kundendienst Alpine Electronics (Europe) GmbH senden.
Frankfurter Ring 117, 80807 München, Germany
Phone: 089-32 42 640

Français

En remplissant volontairement cette fiche, et en l'envoyant à Alpine, vous acceptez que ces informations soient utilisées par Alpine, dans le cadre de développement de nouveaux produits. Par ailleurs, vous autorisez Alpine à solliciter votre opinion par mailing sur de nouveaux produits ou services. Si vous acceptez les termes ci-dessus, veuillez signer cette carte à l'endroit indiqué, et nous la retourner. Tout autre commentaire ou demande doit être adressé à l'attention de: Responsable du service consommateur Alpine Electronics (Europe) GmbH.
Frankfurter Ring 117, 80807 München, Germany
Phone: +49-(0)89-32 42 640

Español

El envío de la información solicitada es voluntario. Si Vd. nos la remite, será utilizada de modo confidencial para el desarrollo de futuros productos Alpine. Si Vd. desea recibir información sobre nuevos productos de nuestra gama, indique su nombre en el espacio designado y remitanos la tarjeta. Cualquier solicitud adicional puede ser enviada a: Persona responsable del Servicio de Atención al Cliente de Alpine Electronics (Europe) GmbH.
Frankfurter Ring 117, 80807 München, Germany
Phone: +49-(0)89-32 42 640

Q1. PRODUCT PURCHASED

1. Cassette Player
2. CD Player
3. MD Player
4. DVD Player
5. CD Changer
6. Amplifier
7. Speaker
8. Subwoofer
9. Monitor Controller
10. Video Monitor
11. Navigation
12. Processor/Equalizer
13. CD/Video CD Changer
14. Other _____

Q2. MODEL NUMBER: _____

Q3. DATE OF PURCHASE:

Month: _____ Year: _____

Q4. If navigation system, which monitor?

1. Alpine → (Model No.) _____
2. Other → (Brand Name) _____

Q5. STORE TYPE WHERE PURCHASED:

1. Car Audio Specialist
2. Audio/Video Store
3. Electronics/Appliance Store
4. Car Accessories Shop
5. Other _____

Q6. Type of vehicle in which this unit is installed:

Make: _____ Model: _____
Purchased Model _____
Year: _____ Year: _____

Q7. How was this vehicle purchased?

1. Purchase
2. Lease

Q8. Purpose of buying this unit?

1. Addition
2. Replacement

↓
• Previous brand replaced?

1. Factory installed
2. Alpine
3. Other → (Brand Name) _____

Q9. Have you purchased Alpine products before?

1. First time
2. Two or More times

Q10. When you purchased this Alpine unit, did you compare it with other brand?

1. Yes → (Brand Name) _____
2. No

Q11. GENDER

1. Male
2. Female

Q12. AGE _____

Q13. MARITAL STATUS

1. Single
2. Married

Q14. OCCUPATION

1. Company Owner/Self-employed/
Freelance
2. Manager
3. Company Employee
4. Civil Servant
5. Educator
6. Student
7. Other _____

Q15. Comments _____

Q1. gekauftes Gerät

1. Kassetten-Spieler
2. CD-Spieler
3. MD-Spieler
4. DVD-Spieler
5. CD-Wechsler
6. Verstärker
7. Lautsprecher
8. Subwoofer
9. Monitor-Controller
10. Video-Monitor
11. Navigationssystem
12. Prozessor/Equalizer
13. CD/Video-CD-Wechsler
14. andere _____

Q2. Modellnummer: _____

Q3. Kaufdatum:

Monat: _____ Jahr: _____

Q4. Falls Navigationssystem: Welcher Monitor?

1. Alpine → (Modellnr.) _____
2. Anderer Hersteller →
(Herstellername) _____

Q5. Art des Geschäfts, in dem Sie das Gerät gekauft haben:

1. Spezialist für Auto-Audioanlagen
2. Audio/Video-Geschäft
3. Elektro-Geschäft
4. Autozubehör-Geschäft
5. Anderer Hersteller _____

Q6. Art des Fahrzeugs, in das das Gerät installiert wurde:

Marke: _____ Modell: _____
gekauft im _____
Jahr: _____ Baujahr: _____

Q7. Wie haben Sie das Fahrzeug gekauft?

1. Kauf
2. Leasing

Q8. Zweck des Kaufs dieses Geräts?

1. Zusätzlich
2. Austausch

↓
• Marke des ausgetauschten Geräts?

1. Serienmäßige Ausstattung
2. Alpine
3. Anderer Hersteller →
(Herstellername) _____

Q9. War dies das erste Mal, dass Sie ein Alpine-Gerät gekauft haben?

1. Erstes Mal
2. Zweites Mal oder öfter

Q10. Haben Sie dieses Alpine-Gerät vor dem Kauf mit Geräten anderer Hersteller verglichen?

1. Ja → (Herstellername) _____
2. Nein

Q11. Geschlecht

1. Männlich
2. Weiblich

Q12. Alter _____

Q13. Familienstand

1. Ledig
2. Verheiratet

Q14. Beruf

1. Selbständige/Firmeninhaber/freiberuflich
Tätige
2. Leitende Angestellte
3. Sonstige Angestellte
4. Beamte
5. Schulbildung
6. Studium
7. Sonstige _____

Q15. Kommentar: _____

Q1. PRODUIT ACHETE

1. Lecteur de cassette
2. Lecteur de CD
3. Lecteur MD
4. Lecteur DVD
5. Changeur de CD
6. Amplificateur
7. Haut-parleur
8. Haut-parleur de graves
9. Station Multimedia
10. Moniteur Vidéo
11. Navigation
12. Processeur/Egaliseur
13. Changeur de CD/CD Vidéo
14. Autre _____

Q2. NUMERO DU MODELE: _____

Q3. DATE D'ACHAT:

Mois: _____ Année: _____

Q4. Si c'est un système de navigation, quel moniteur?

1. Alpine → (N° du modèle) _____
2. Autre → (Marque) _____

Q5. TYPE DE MAGASIN OU VOUS AVEZ ACHETE LE PRODUIT:

1. Spécialiste autoradio
2. Magasin audio/vidéo
3. Magasin d'électronique/appareils
4. Magasin d'accessoires automobiles
5. Autre _____

Q6. Type de véhicule dans lequel cet appareil est installé:

Marque: _____ Modèle: _____
Année _____ Année du
d'achat: _____ modèle: _____

Q7. Comment avez-vous acheté ce véhicule?

1. Achat
2. Location-bail

Q8. Pourquoi avez-vous acheté cet appareil?

1. Addition
2. Remplacement

↓
• Marque précédente remplacée?

1. Installé en usine
2. Alpine
3. Autre → (Marque) _____

Q9. Aviez-vous déjà acheté des produits Alpine?

1. Première fois
2. Deux fois ou plus

Q10. Lorsque vous avez acheté ce produit Alpine, l'avez-vous comparé à une autre marque?

1. Oui → (Marque) _____
2. Non

Q11. SEXE

1. Masculin
2. Féminin

Q12. AGE _____

Q13. SITUATION DE FAMILLE

1. Célibataire
2. Marié

Q14. PROFESSION

1. Entrepreneur/Travailleur indépendant/
Free-lance
2. Directeur
3. Employé de bureau
4. Fonctionnaire
5. Educateur
6. Etudiant
7. Autre _____

Q15. Commentaires _____

Q1. Producto Comprado

1. Radio/Cassette
2. Radio/CD
3. Reproductor de MD
4. Reproductor de DVD
5. Cambiador de CD
6. Amplificador
7. Altavoz
8. Subwoofer
9. Monitor de control
10. Monitor de video
11. Sistema de navegación
12. Procesador/Ecualizador
13. Cambiador de CD/Video CD
14. Otros _____

Q2. Número de modelo: _____

Q3. Fecha de compra:

Mes: _____ Año: _____

Q4. En caso de sistema de navegación, ¿qué monitor?

1. Alpine → (N° de modelo) _____
2. Otros → (Nombre de marca) _____

Q5. TIPO DE TIENDA DONDE COMPRÓ:

1. Especialista en audio de automóviles
2. Tienda de audio/Video
3. Tienda de electrónica/electrodomésticos
4. Tienda de accesorios automovilísticos
5. Otros _____

Q6. Tipo de vehículo en que la unidad está instalada:

Marca: _____ Modelo: _____
Año de _____ Año del
compra: _____ modelo: _____

Q7. ¿Cómo fue comprado este vehículo?

1. compra
2. Leasing

Q8. ¿Propósito de comprar esta unidad?

1. Mejora del sistema
2. Sustitución

↓
• ¿Sustitución de marca anterior?

1. Instalado en la fábrica
2. Alpine
3. Otros → (Nombre de marca) _____

Q9. ¿Ha comprado Vd. productos Alpine anteriormente?

1. Primera vez
2. Dos o más veces

Q10. Cuando usted compró esta unidad Alpine, ¿la comparó con otros fabricantes?

1. Si → (Nombre de marca) _____
2. No

Q11. SEXO

1. Masculino
2. Femenino

Q12. Edad _____

Q13. Estado civil

1. Soltero
2. Casado

Q14. Ocupación

1. Propietario de empresa/Autónomo/
Profesional independiente
2. Gerente
3. Empleado de compañía
4. Empleado público
5. Profesor
6. Estudiante
7. Otros _____

Q15. Comentarios _____

Scheda informazioni prodotto

Italiano

La compilazione di questo formulario è volontaria. Se compilate questo formulario, ritornandolo ad Alpine, i Vostri dati saranno raccolti in un file di riferimento per lo sviluppo dei nuovi prodotti Alpine. In aggiunta Voi potrete ricevere in futuro informazioni riguardanti i nuovi prodotti o la richiesta di una Vostra opinione circa i prodotti o i servizi forniti da Alpine. Se siete d'accordo, Vi preghiamo di ritornarci il formulario compilato negli appositi spazi con i Vostri dati. In caso desideriate fornire altri commenti o richiedere informazioni aggiuntive, potete indirizzare il tutto a : Responsabile dipartimento Servizio Clienti Alpine Electronics (Europe) GmbH.
Frankfurter Ring 117, 80807 München, Germany
Phone: +49-(0)89-32 42 640

Q1. PRODOTTO ACQUISTATO

1. Lettore di cassette
2. Lettore CD
3. Lettore MD
4. Lettore DVD
5. CD Changer
6. Amplificatore
7. Altoparlante
8. Subwoofer
9. Radio Monitor
10. Monitor video
11. Sistema di navigazione
12. Processore/equalizzatore
13. Cambia CD/Video CD
14. Altro _____

Q2. NUMERO MODELLO: _____

Q3. DATA DI ACQUISTO:

Mese: _____ Anno: _____

Q4. In caso di acquisto di un sistema di navigazione, quale monitor possiede?

1. Alpine → (No. Modello) _____
2. Altro → Nome marca _____

Q5. NEGOZIO DI ACQUISTO:

1. Specialista Car Stereo
2. Negozio di audio/video
3. Negozio di elettronica/elettrodomestici
4. Negozio accessori automobile
5. Altro _____

Q6. Tipo di veicolo posseduto:

Marca: _____ Modello: _____
Anno _____ Anno _____
acquisto: _____ modello: _____

Q7. Modalità acquisto

1. Acquisto
2. Leasing

Q8. Scopo acquisto

1. Aggiunta
2. Sostituzione
- ↓
- Marca sostituita
1. Installato di fabbrica
2. Alpine
3. Altro → (Nome marca) _____

Q9. Avevate già acquistato prodotti Alpine?

1. No
2. Due o tre volte

Q10. Nell'acquistarlo, avete paragonato questo prodotto ad un'altra marca?

1. Sì → (Nome marca) _____
2. No

Q11. SESSO

1. Maschile
2. Femminile

Q12. ETA

Q13. STATO CIVILE

1. Celibe/nubile
2. Coniugato/coniugata

Q14. LAVORO

1. Proprietario di azienda/artigiano/libero professionista
2. Manager
3. Impiegato
4. Impiegato statale
5. Insegnante
6. Studente
7. Altro _____

Q15. Commenti _____

- ◆ I agree to the above stated terms of the Alpine Product Information Card.
- ◆ Ich stimme dem Kontakt durch Alpine für Informations- und Befragungszwecke zu.
- ◆ J'accepte les termes de cette carte d'information produit Alpine.
- ◆ Estoy conforme con los términos de la tarjeta de información sobre producto de Alpine.
- ◆ Accetto i termini della scheda informazioni prodotti Alpine.

_____ (Date/Datum/Date/Fecha/Data)

_____ (Signature/Unterschrift/Signature/Firma)

Name/Nom/Nombre/Nome

(First Name/Vorname/Prénom/Primer nombre/Nome)

(Surname/Familiename/Nom de famille/Apellido/Cognome)

Home Address/Privatanschrift/Adresse/Dirección/Indirizzo

(Street/Straße/Rue/Calle/Via) (Post Code/Postleitzahl/Code postal/Código postal/Codice postale)

(Town/City/Stadt/Ville/Ciudad/Città) (Country/Land/Pays/Pais/Paese)

Telephone Number: _____

E-Mail/Correo electrónico: _____

Q1 NO. Other	Q2
--------------------	----

Q3 Month	Year	Q4 NO.1. Model No.
		NO.2. Brand Name

Q5 NO. Other	Q6 Make:	Model:
	Purchased Year:	Model Year:

Q7 NO.	Q8 NO. 1	Previous brand replaced.	Brand Name
	2	1. 2. 3. →	

Q9 NO.	Q10 1 → Brand Name	Q11 NO.
	NO. 2	

Q12 years old	Q13 NO.	Q14 NO. Other
--------------------------	------------	---------------------

Q15 Comments _____

LUFTPORT
PAR AVION
PRIORITAIRE

NE PAS AFFRANCHIR

NICHT FREIMACHEN
NO STAMP REQUIRED

REPOSE PAYEE/ WERBEANTWORT
ALLEMAGNE

ALPINE ELECTRONICS (EUROPE) GmbH
Frankfurter Ring 117, 80807 München,
Germany